

har-bus® HM connectors are the basis for configuring high-performing backplanes for control and industrial computer systems in 19" technology. These connectors are standardized for the CompactPCI and the VME64x bus. All connectors are designed for press-in technology, the female connectors are also available as a solder version.

Application profile:

CONNECTION TYPE		ENVIRONMENT		APPLICATION						
Board to Board	Cable/Wire to Board	IP 20	IP 65 / IP 67	Data	Signal	Power	high performance			
							Data transfer rate	Shielding	Number of contacts, contact density	Voltage, working current
Cable termination			PCB termination			Application standard				
Han-Quick Lock® 	IDC 	Crimp 	THT 	SMC 	SMT 	CompactPCI				
Screw 	Cage clamp 	Axial screw 	Press-in 	Housing integration Separate housing				Integrated housing		

CONTENTS	PAGE
<i>harbus</i>[®] HM Standard	
Introduction	11.02
General information	11.04
Types A, B, AB, C with 5 + 2 rows	
Straight male connectors	11.12
Angled female connectors	11.24
Type Monoblock 47	
Straight male connectors	11.28
Angled female connectors	11.30
Types D, E, DE with 8 + 2 rows – Straight male connectors	11.32
SMC (Surface Mount Compatible) types A, B, AB, C with 5 + 2 rows – Angled female connectors	11.35
<i>harbus</i>[®] HM Power	
General information	11.40
Angled male connectors	11.42
Straight female connectors	11.44
Accessories	
Coding keys	11.45
Shrouds	11.46
Guiding system	11.51
Customer request form	11.52

HARD METRIC CONNECTORS *har-bus*[®] HM IN 2.00 mm PITCH

har-bus[®] HM connectors are the basis for configuring high-performing backplanes for control and industrial computer systems in 19" technology.

HARTING offers 5 row and 8 row 2 mm hard metric connectors *har-bus*[®] HM according to IEC 61076-4-101. The product family includes all standard types such as all variants for CompactPCI, inclusive Hot Swap and CTI (Computer Telephony Integration). The modules are defined as the 5+2 row types A, B, AB and C and the 8+2 row types D, E and DE. All male and female connectors are available with press-in terminations. Moreover the female

connectors are offered for Pin in Hole Intrusive Reflow (PiHIR) technology as well.

The high current *har-bus*[®] HM Power connector complies with the OBSAI specification V1.1. This very compact connector can be loaded with up to four contacts, each contact carrying up to 23 A at 70 °C (in OBSAI configuration). The connector is offered in four lengths to allow hot swapping. The right-angled male connectors are available for press-in and for PiHIR soldering.

Accessories and press-in tooling are available for all connectors.

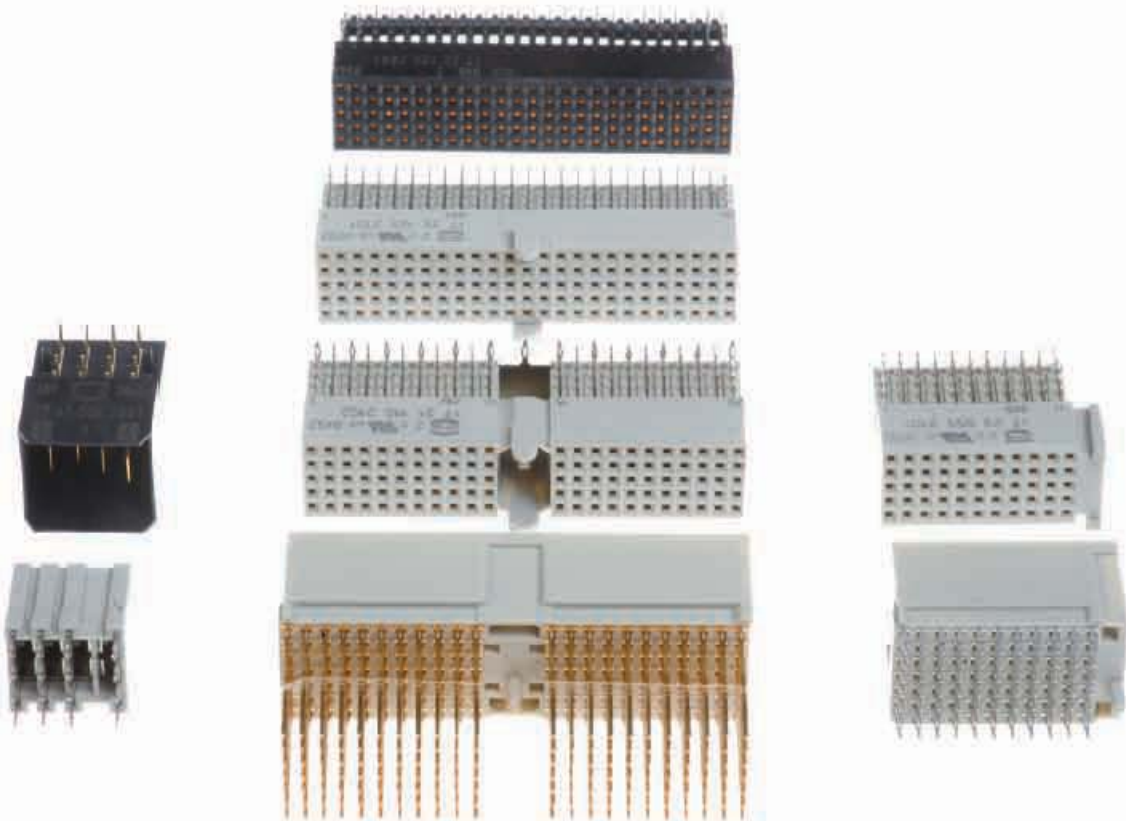

COMBINED STYLE FOR CompactPCI:

Additional to the standard insulator types according to the specification there is a Monoblock available, especially for CompactPCI applications. It unites the type A and the type B₂₂ in one connector. With the Monoblock, only one connector is necessary for a standard configuration of a 3U module card which offers a cost advantage in the production process and logistics.

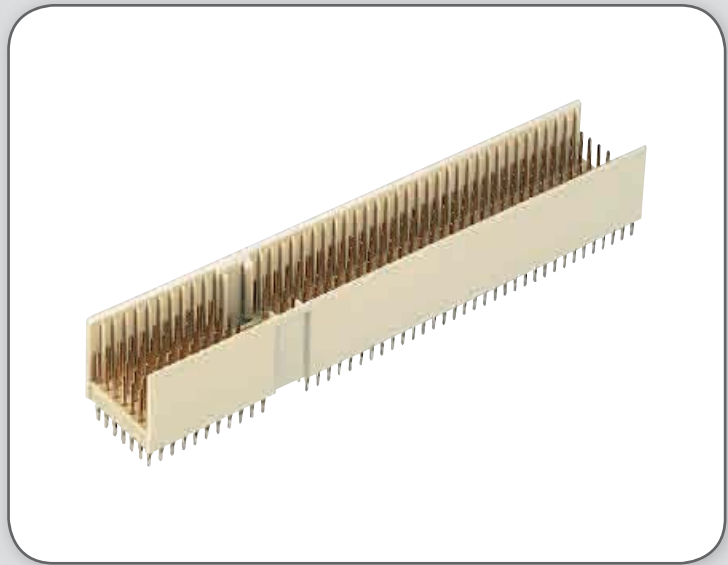

“NEEDLE-EYE” PRESS-IN TECHNOLOGY:

The *har-bus*[®] HM press-in zone is based on the industry renowned needle-eye technology. Its special design allows for compensation of tolerances of pcb surface properties (e.g. superfluous tin plating). The excessive material is displaced within the plated through hole, whereby a gas-tight and corrosion resistant electrical connection is assured.

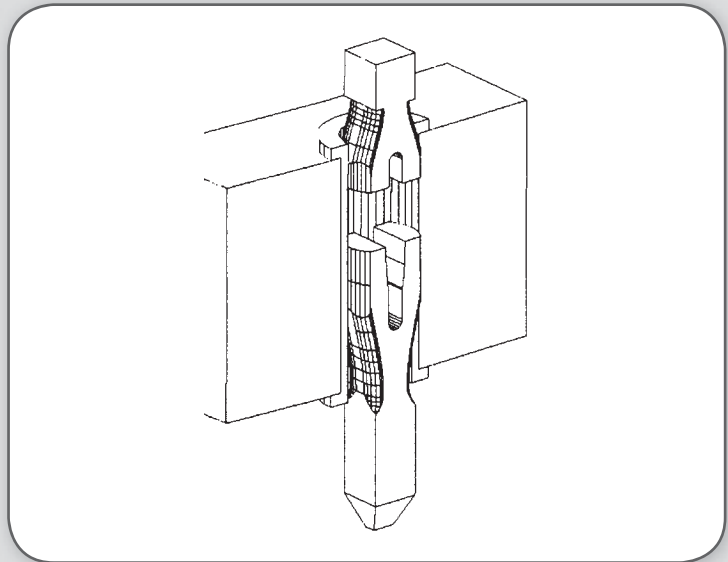

har-bus[®]
HM

INTERNATIONAL STANDARD:

The *har-bus*[®] HM connectors are designed to meet the PICMG 2.x specification and can be used in CompactPCI. CompactPCI is a common standard e.g. for industrial computers.



Design according	: IEC 61 076-4 - 101
Approvals	
Underwriters Laboratories Inc. [®]	:  us with their respective ratings documented in file E 102079
Number of contacts	: 55 – 220 signal (77 – 308 fully shielded); or customised
Contact spacing	: 2.00 mm
Working current	: 1 A @ 70 °C (80 % derating)
Test voltage $U_{r.m.s.}$: AC 750 V min.
Contact resistance	: 20 mΩ max.
Insulation resistance	: 10 GΩ min.
Temperature range	: – 55 °C ... + 125 °C
Durability as per IEC 61076-4-101	: Performance level 2 = 250 mating cycles in total. <i>First 125 mating cycles, then 4 days gas test using 0.5 ppm SO₂ and 0.1 ppm H₂S (at 25 ± 2 °C and 75 ± 3 % humidity). Measurement of contact resistance.</i> <i>The remaining 125 mating cycles are subject to measurement of contact resistance and visual inspection. No abrasion of the contact finish through to the base material. No functional impairment.</i> Performance level 1 = 500 mating cycles in total. <i>First 250 mating cycles, then 10 days gas test using 0.5 ppm SO₂ and 0.1 ppm H₂S (at 25 ± 2 °C and 75 ± 3 % humidity). Measurement of contact resistance.</i> <i>The remaining 250 mating cycles are subject to measurement of contact resistance and visual inspection. No abrasion of the contact finish through to the base material. No functional impairment.</i>
Termination technique	: compliant press-in
Mating force	: 0.75 N/pin max.
Withdrawal force	: 0.15 N/pin min.
Materials	
Mouldings	: Thermoplastic resin, glass-fibre filled, UL 94-V0
Contacts	: Copper alloy
Contact surface	
Contact zone male	: Au/PdNi/Ni, contacts are treated with Bellcore recommended lubricant (PPE)
Contact zone female	: Au/Ni, contacts are treated with Bellcore recommended lubricant (PPE)
Press-in zone	: Ni
Packaging	: Tube

Due to the high deformation capability and resilience of **harbus[®] HM** press-in contacts, they can be easily and repeatedly removed in case of repairs without impairment to their functioning.

harbus[®] HM press-in contacts are extremely versatile and offer a reliable electrical contact, therefore they are especially well suited for applications with these surfaces.

Please contact us for detailed test reports.

Benefits of press-in technology

- Thermal shocks associated with the soldering process and the risk of the board malfunction are avoided.
- No need for the subsequent cleaning of the assembled pcb's
- Unlimited and efficient processing of partially gold-plated pins for rear I/O - manual soldering is no longer necessary!

Recommended configuration of plated through holes

In addition to the hot-air-level (HAL), other pcb surfaces are getting more important. Due to their different properties, such as mechanical strength and coefficient of friction we recommend the following configuration of pcb through holes.

<i>Tin plated PCB (HAL) acc. EN 60352-5</i>	Hole-Ø	0.7 ^{±0.02} mm
	Cu	min. 25 µm
	Sn	max. 15 µm
	Plated hole-Ø	0.60-0.65 mm
<i>Chemical tin plated PCB</i>	Hole-Ø	0.7 ^{±0.02} mm
	Cu	min. 25 µm
	Sn	min. 0.8 µm
	Plated hole-Ø	0.60-0.65 mm
<i>Au / Ni plated PCB</i>	Hole-Ø	0.7 ^{±0.02} mm
	Cu	min. 25 µm
	Ni	3-7 µm
	Au	0.05-0.12 µm
	Plated hole-Ø	0.60-0.65 mm
<i>Silver plated PCB</i>	Hole-Ø	0.7 ^{±0.02} mm
	Cu	min. 25 µm
	Ag	0.1-0.3 µm
	Plated hole-Ø	0.60-0.65 mm
<i>OSP copper plated PCB</i>	Hole-Ø	0.7 ^{±0.02} mm
	Cu	min. 25 µm
	Plated hole-Ø	0.60-0.65 mm

PCB board thickness: ≥ 1.4 mm

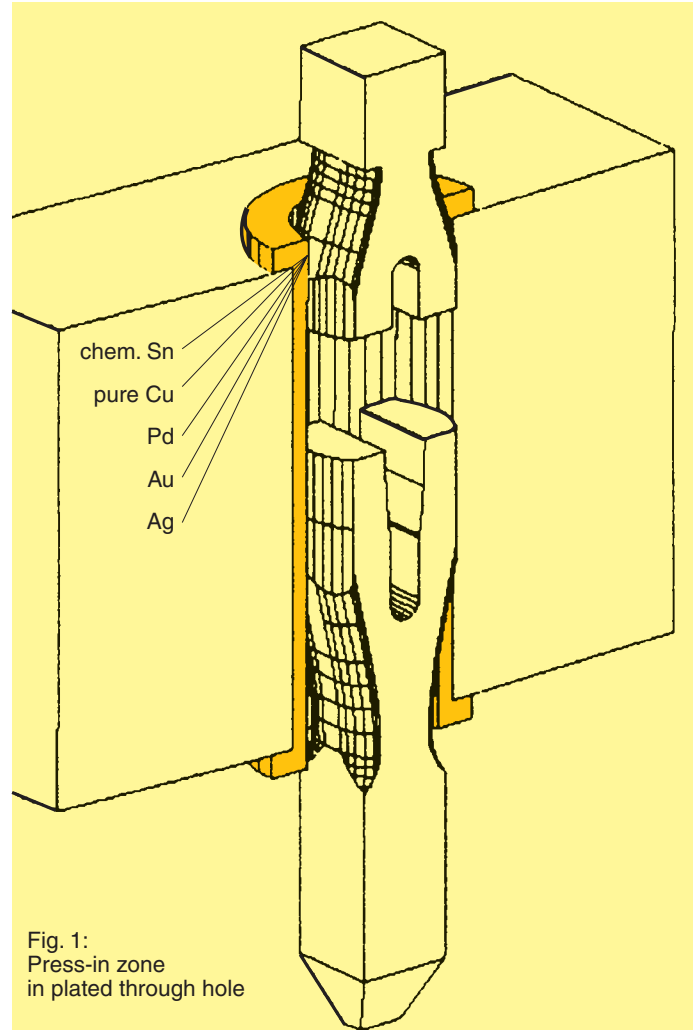

Fig. 1: Press-in zone in plated through hole

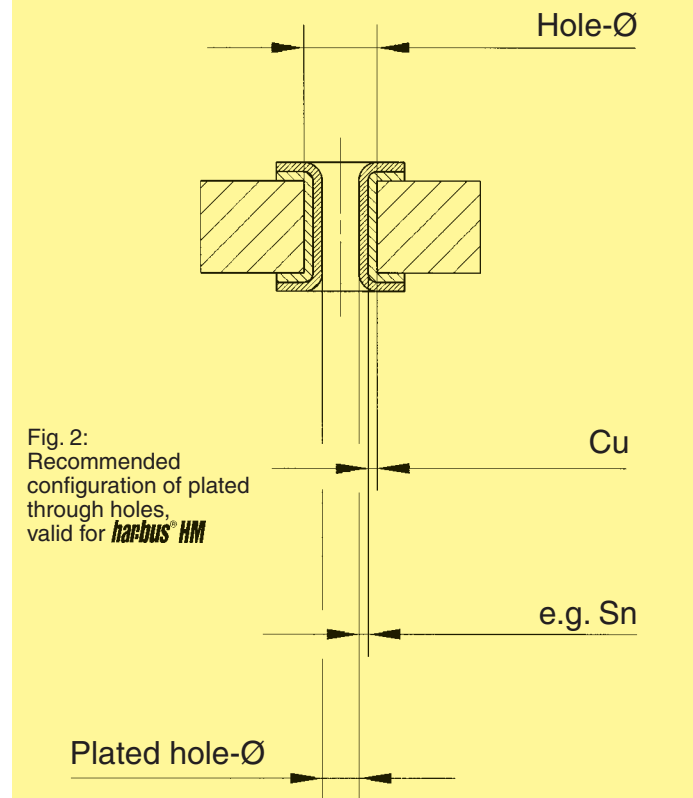

Fig. 2: Recommended configuration of plated through holes, valid for **harbus[®] HM**

HARTING offers 13 contact lengths for *harbus[®] HM* male connectors: the standard mating length of 8.2 mm, pre-leading contacts with 9.7 mm and extra long contacts preferred for shielding with 11.2 mm mating length.

On the termination side the standard length is 3.7 mm. With the three termination lengths of 13.0, 14.5 and 16.0 mm even for rear I/O applications different mating levels are possible, depending on the pcb thickness and shroud height.

For the standard termination length, an extra short contact for special applications with a mating length of 7.2 mm is available.

The different contact lengths are designated with letters to identify them in the configurations. For special loadings please use the customer request form at the end of this chapter.

All contacts are offered with press-in termination 'eye of the needle'. In accordance with the application they can be delivered in performance level 1 or 2.

Contact dimensions [mm]

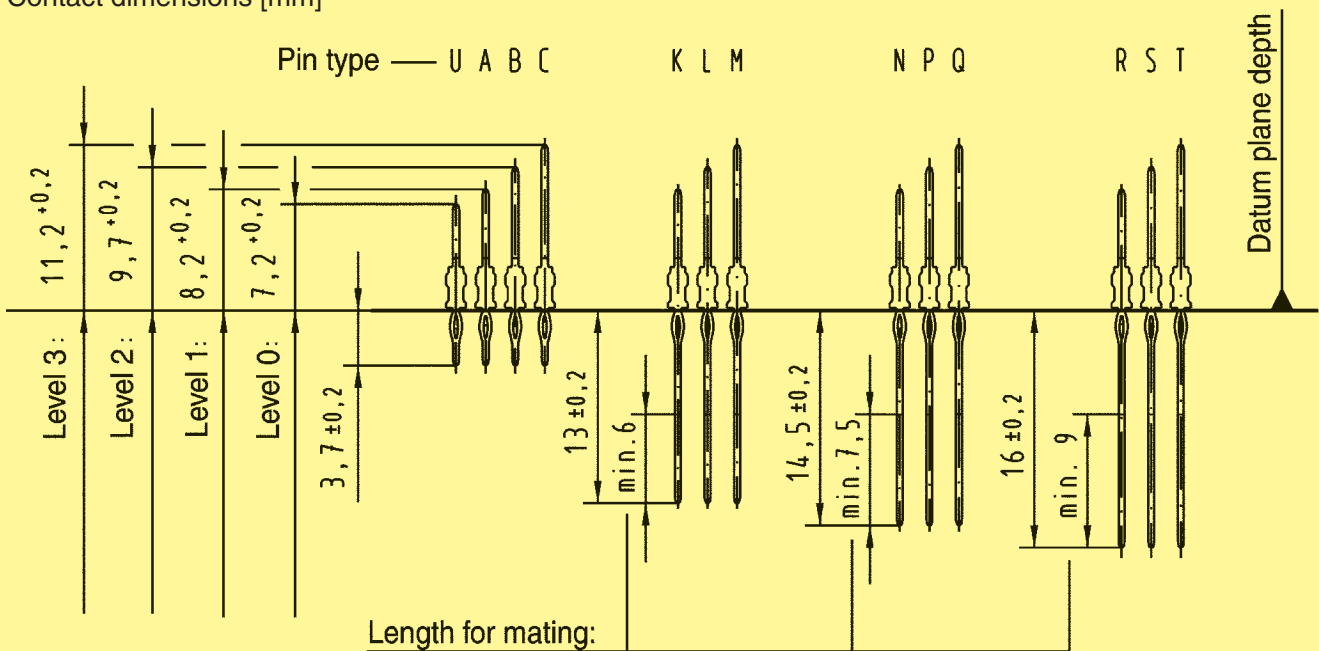

Circuit density

When using the specified diameter of the finished through hole according to IEC 61076-4-101 (0.6 ± 0.05 mm) with an appropriate annular ring, the remaining distance between the rings is about 1 mm. Under the condition that the width of the track and the space between should be equal, two tracks of 0.2 mm width or three tracks of 0.14 mm width can be placed between two rings. Typical designs are shown in the drawing on the right side.

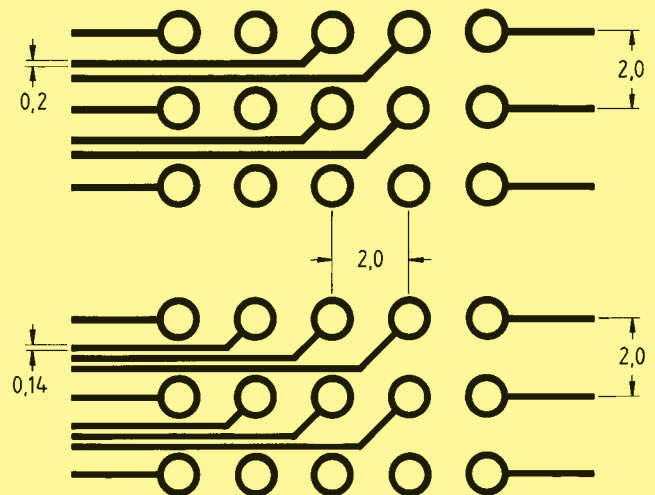

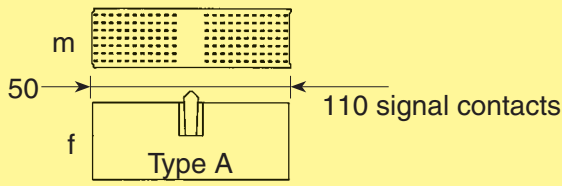

All HARTING *harbus[®] HM* connectors can be assembled end to end in any configuration.

General rules:

- Type B connectors should always be used in combination with an A type and/or C type connectors that are fitted with alignment features.
- Type C connectors must be assembled at the end of a connector stack, to achieve polarisation and avoid mismatching.
- To ensure the correct slot position of connector stacks coding can be added with type A connectors.
- Starting with an type A module (50 mm) any module can be added within the above recommendation (see typical examples shown in the diagram).

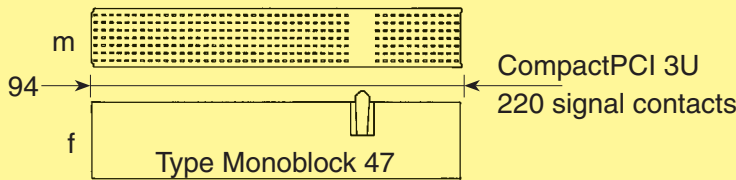
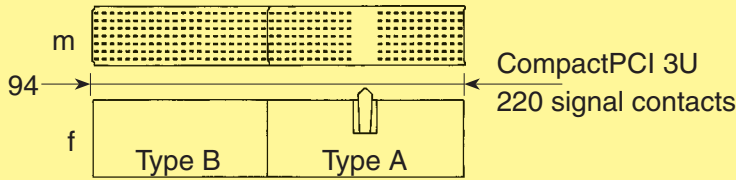

m = male connector
f = female connector

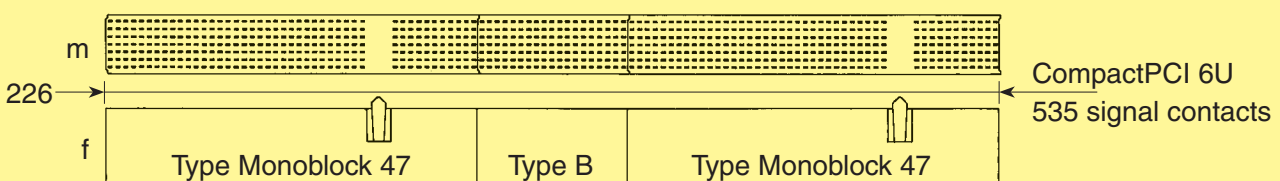
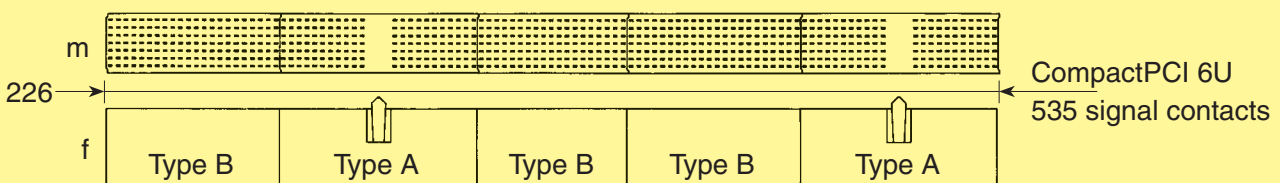
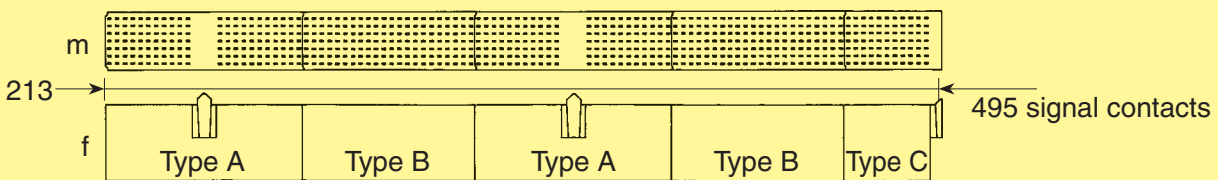
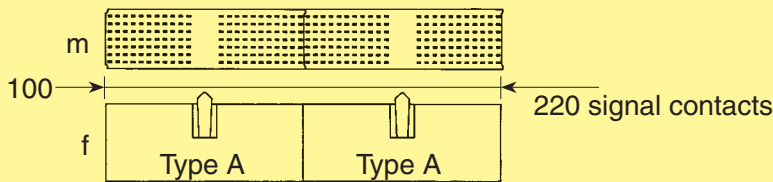

Improved guiding with AB-modules:

In accordance with the equipment practice each front side arrangement of harbus[®] HM connectors shall have at least one A-module per slot to ensure that the connector can accommodate ± 2 mm alignment tolerances in rack systems.

On some rear I/O arrangements the A-module's alignment capability cannot be utilised, because only B-modules are used for feed through. Consequently AB-modules were introduced to ensure guiding capabilities where formerly only B-modules were used. Those AB-modules represent a combination of A- and B-modules and are specified in **CompactPCI by PICMG 2.0 Rev. 3.0** for certain rear I/O applications.

The AB-modules have guiding pegs similar (but not mating compatible to prevent mismating) to those

of the A-module providing the same proven mating tolerances of ± 2 mm. The AB-modules have no coding center but are fully equipped with contacts in order to maintain the full density as per the B-modules.

The **AB-female** connector mates either with an **AB-shroud** or with **AB-male** connectors. The centered pin positions of the shielding rows of male connectors are simply equipped with short spill contacts (if standard connector and shroud are used). This prevents that the guiding peg of the female AB-module stubbing on the feed through contacts of the front side's fixed connector. These fixed connector loadings are called **AB-friendly**.

The AB-male connector will not be equipped with shielded contacts in the centre where the guiding peg will engage.

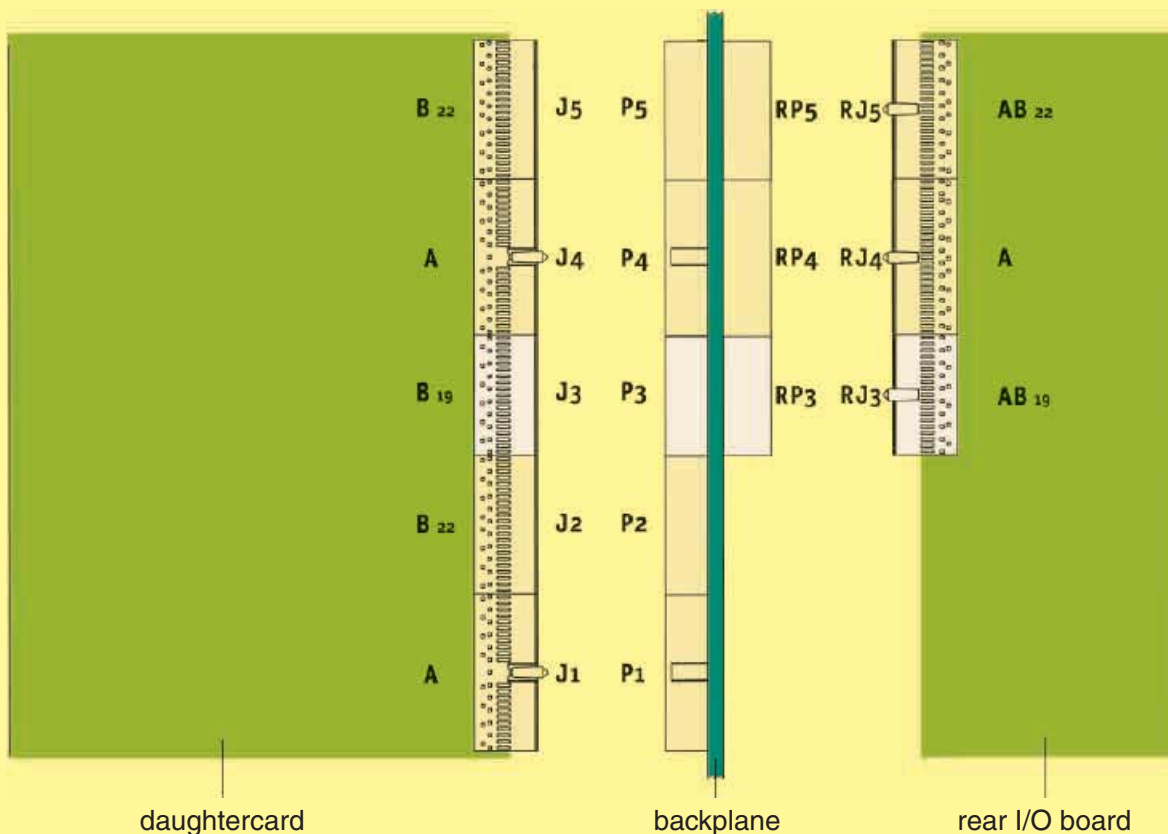
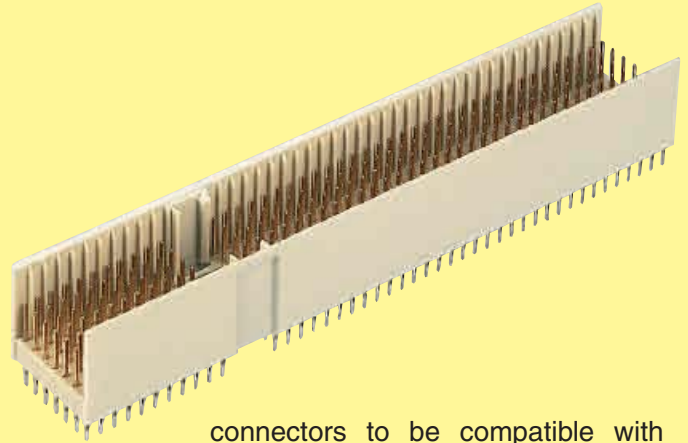

Fig. 3: CompactPCI 6U configuration

CompactPCI[®] as a standard is maintained and enhanced by the PCI Industrial Computer Manufacturers Group (PICMG[®]). It defines a combination of the electrical and logical specifications of the PCI standard and the mechanical specifications of the IEEE 1101 and IEC 60297 series of standards. The board connector has been developed from the IEC 61076-4-101 series of 2.0 mm connectors. The mounting location and dimensions for the 2.0 mm connectors are specified in IEEE 1101.11. Some additional mechanical definitions for 2.0 mm connectors in the Eurocard format are being specified in the VITA 30 draft.

Other international standards are listed in the CompactPCI[®] standard for environmental and

Slave or peripheral boards need J1/P1 as a minimum, master or system boards need both J1/P1 and J2/P2 as a minimum. Backplanes should always have the full complement of



connectors to be compatible with any type of board. As opposed to the CPCI standard (pins numbered from bottom to top), the contact numbers on the connector are numbered from top to bottom (according to the IEC standard).

The front panel of CPCI cards may be equipped with additional keying pegs to code individual board types. There is also an extended pin length to remove any electro static charge before contacts on the rear connectors mate.

This pin also functions as a mechanical guide to position the board as straight as possible for insertion. This prevents pin bending and lowers the insertion force.

Some applications could require up to 500 pins to be pushed into sockets simultaneously.

Connectors for high availability applications (hot swap) come with 3 different lengths of pins for a staged sequence of mate or break of contact.

Connector J1/P1 carries the signals for a 32 bit PCI bus (see table of contact assignments for J1/P1). Connector J2/P2 on a system card has the additional signals for a 64 bit PCI bus and some user-defined I/O (see table of contact assignments for J2/P2). On slave cards all of J2/P2 might be user-defined I/O except the top row which carries the signals for geographical addressing. J3/P3 should be reserved for other system bus definitions. J4/P4 and J5/P5 are used for I/O or secondary buses, e.g. H.110 in telecom applications or for bridges into other buses like VMEbus.

This is used to accommodate two bus platforms in one card cage on one backplane.

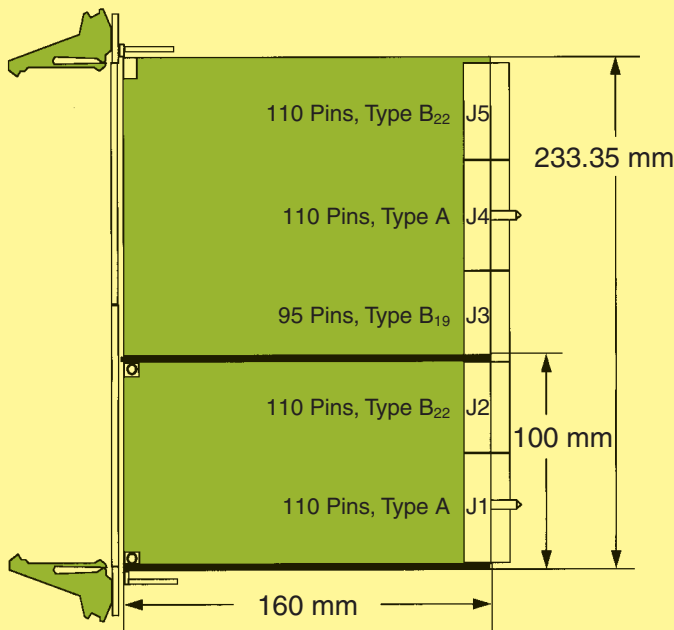

related specifications. This gives CompactPCI[®] a solid foundation of international standards and practices for mechanical robustness.

The board format is either a 3U or a 6U Eurocard as defined in IEC 60297. There are two or five connectors specified for 3U or 6U boards respectively. Connectors are numbered from J1/P1 through J5/P5 (bottom to top) on the board or backplane.

Contact assignment on CompactPCI[®] system position (J1/P1)

	a	b	c	d	e	
25	+5 V	REQ64#	ENUM#	+3,3 V	+5 V	25
24	AD[1]	+5 V	V(I/O)	AD[0]	ACK64#	24
23	+3,3 V	AD[4]	AD[3]	+5 V	AD[2]	23
22	AD[7]	GND	+3,3 V	AD[6]	AD[5]	22
21	+3,3 V	AD[9]	AD[8]	M66EN	C/BE[0]#	21
20	AD[12]	GND	V(I/O)	AD[11]	AD[10]	20
19	+3,3 V	AD[15]	AD[14]	GND	AD[13]	19
18	SERR#	GND	+3,3 V	PAR	C/BE[1]#	18
17	+3,3 V	SDONE	SBO#	GND	PERR#	17
16	DEVSEL#	GND	V(I/O)	STOP#	LOCK#	16
15	+3,3 V	FRAME#	IRDY#	GND	TRDY#	15
14						14
13	Key Area					13
12						12
11	AD[18]	AD[17]	AD[16]	GND	C/BE[2]#	11
10	AD[21]	GND	+3,3 V	AD[20]	AD[19]	10
9	C/BE[3]#	IDSEL	AD[23]	GND	AD[22]	9
8	AD[26]	GND	V(I/O)	AD[25]	AD[24]	8
7	AD[30]	AD[29]	AD[28]	GND	AD[27]	7
6	REQ#	GND	+3,3 V	CLK	AD[31]	6
5	Bus Reserved	Bus Reserved	RST#	GND	GNT#	5
4	Bus Reserved	GND	V(I/O)	INTP	INTS	4
3	INTA#	INTB#	INTC#	+5 V	INTD#	3
2	TCK	+5 V	TMS	TDO	TDI	2
1	+5 V	-12 V	TRST#	+12 V	+5 V	1
	a	b	c	d	e	

Contact assignment on CompactPCI[®] system position (J2/P2)

	a	b	c	d	e	
22	GA4	GA3	GA2	GA1	GA0	22
21	CLK6	GND	Reserved	Reserved	Reserved	21
20	CLK5	GND	Reserved	GND	Reserved	20
19	GND	GND	Reserved	Reserved	Reserved	19
18	Bus Reserved	Bus Reserved	Bus Reserved	GND	Bus Reserved	18
17	Bus Reserved	GND	PRST#	REQ6#	GNT6#	17
16	Bus Reserved	Bus Reserved	DEC#	GND	Bus Reserved	16
15	Bus Reserved	GND	FAL#	REQ5#	GNT5#	15
14	AD[35]	AD[34]	AD[33]	GND	AD[32]	14
13	AD[38]	GND	V(I/O)	AD[37]	AD[36]	13
12	AD[42]	AD[41]	AD[40]	GND	AD[39]	12
11	AD[45]	GND	V(I/O)	AD[44]	AD[43]	11
10	AD[49]	AD[48]	AD[47]	GND	AD[46]	10
9	AD[52]	GND	V(I/O)	AD[51]	AD[50]	9
8	AD[56]	AD[55]	AD[54]	GND	AD[53]	8
7	AD[59]	GND	V(I/O)	AD[58]	AD[57]	7
6	AD[63]	AD[62]	AD[61]	GND	AD[60]	6
5	C/BE[5]#	GND	V(I/O)	C/BE[4]#	PAR64	5
4	V(I/O)	Bus Reserved	C/BE[7]#	GND	C/BE[6]#	4
3	CLK4	GND	GNT3#	REQ4#	GNT4#	3
2	CLK2	CLK3	SYSEN#	GNT2#	REQ3#	2
1	CLK1	GND	REQ1#	GNT1#	REQ2#	1
	a	b	c	d	e	

In mechanical terms J1/P1 is a 25x5 matrix of contacts. Three rows of 5 contacts (rows 12 - 14) are not used for electrical contacts. Instead, plastic keys of different orientation and configuration are used to key board locations as to system or peripheral slot, voltage options, etc.

J2/P2 is a shortened connector with only 22 rows of contacts instead of 25 rows for a standard size. HARTING now offers monolithic versions with J1/P1 and J2/P2 combined in one single connector.

This combination together with some space left on the card to fit into guide rails makes maximum use of the 100 mm rear edge of the 3U Eurocard.

On a 6U card this connector setup is repeated on J4/P4 and J5/P5.

The J3/P3 connector is a shortened version of the 2.0 mm connector with 19 rows of 5 signal contacts.

The size results from the height of a 6U board (233 mm) which is more than double the height of a 3U board.

All connectors used for CompactPCI[®] are based on a 7 column pitch. The inner 5 columns are used for logic signals and power. The outer columns on either side are reserved for shielding or ground.



Executive Member

The VMEbus has evolved over a period of more than 25 years to become the leading bus architecture in open industrial applications. The specification is an ANSI norm, the original specification has been extended to become a draft standard VME64x ANSI/VITA 1.1-1997. This draft standard includes the specification for the 5-row DIN compatible connector (IEC 61076-4-113) and for a centre connector J0/P0 on 6U VME cards, which is identical to J3/P3 in *CompactPCI*[®] systems.

In VMEbus systems it is possible to use custom connectors in the J0/P0 area (e.g. coax connectors). To prevent problems with non-mating backplanes it is strongly recommended to use front panel keying. The IEEE 1101 documents J0/P0 can also be used with rear transition modules for pluggable I/O cabling. As mentioned above, the contacts on this connector may be bussed. One example is the ATM CellBus, which is in the process of being standardised. The bus on J0/P0 connectors might actually be a plug-on mezzanine backplane rather than conducting traces integrated into the backplane itself.

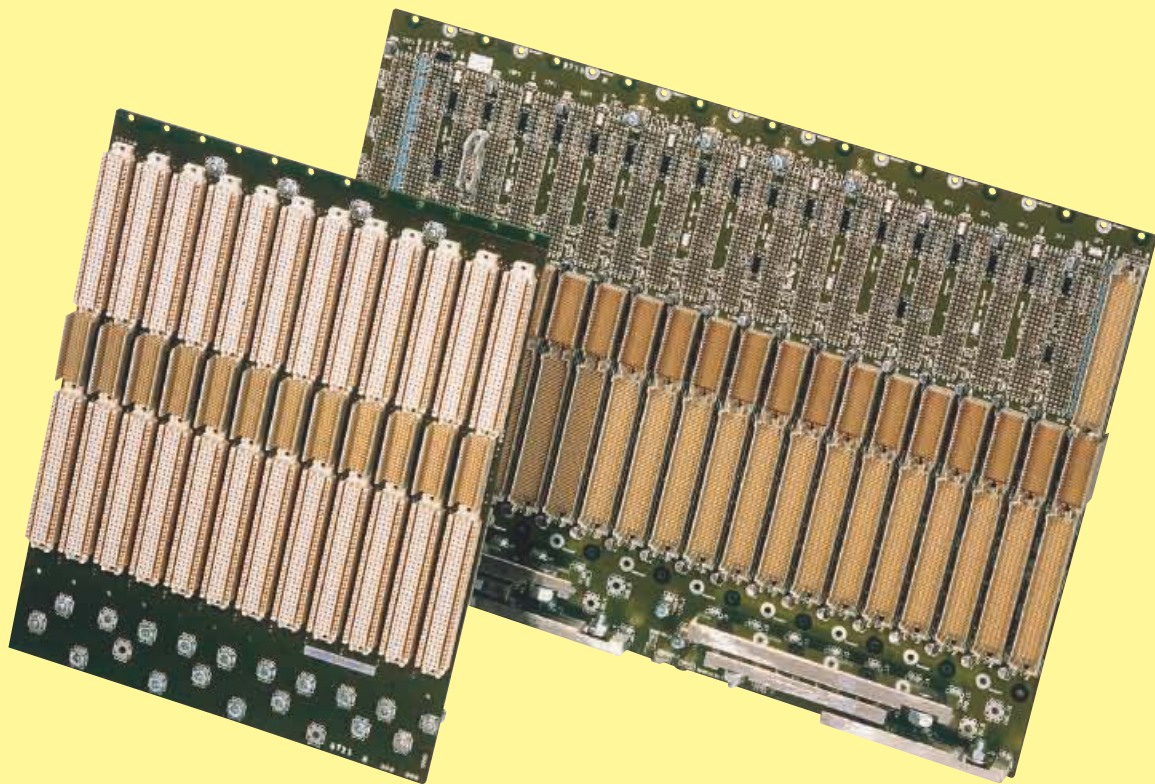

The 2.0 mm J0/P0 connector in VME64x systems is used for additional I/O, for new high speed sub busses or I/O for mezzanine modules, e.g. IP modules on VMEbus boards. The connector is placed on the Eurocard to work in combination with the non-metric original VMEbus connectors DIN 41612 type C or the newer 5-row connector har-bus[®] 64. The mounting location and dimensions for the J0/P0 VMEbus connector (IEC 61076-4-101) is specified in IEEE 1101.11. The VMEbus 2.0 mm connector uses 5 columns of signal contacts and optional two additional outer columns on either side for shielding. All 95 signal contacts are user defined.



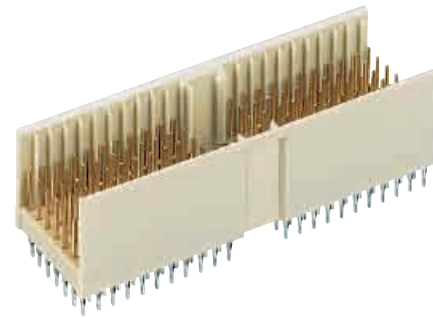

Male connectors, straight

Identification	Number of contacts	Contact length [mm] mating side	termination side	Part number	Contact configuration
Type A	110	8.2	3.7	17 01 110 1201 17 01 110 2201	
Type A	132	8.2/ 11.2	3.7	17 01 132 1203 17 01 132 2203	
Type A	132	8.2/ 11.2	3.7/ 13.0/ 16.0	17 01 132 1007 17 01 132 2007	
Type A	154	8.2/ 11.2	3.7	17 01 154 1201 17 01 154 2201	
Type A	110	9.7	3.7	17 01 110 1204 17 01 110 2204	
Type A	154	9.7/ 11.2	3.7	17 01 154 1205 17 01 154 2205	

harbus[®] HM

Thin print part numbers: performance level 1
Bold print part numbers: performance level 2
 Connector dimensions see page 11.14

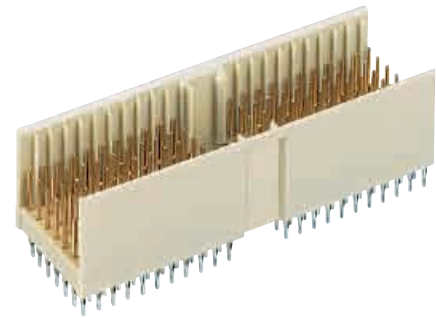

Male connectors, straight

Identification	Number of contacts	Contact length [mm] mating side	termination side	Part number	Contact configuration
Type A	110	8.2	13.0	17 01 110 1402 17 01 110 2402	
Type A	154	9.7/ 11.2	14.5/ 16.0	17 01 154 1001 17 01 154 2001	
Type A CompactPCI Position P1	154	8.2/ 9.7/ 11.2	3.7	17 01 154 1203 17 01 154 2203	
Type A CompactPCI Position P4	154	9.7/ 11.2	16.0	17 01 154 1604 17 01 154 2604	
Type A CompactPCI Position P4	154	8.2/ 9.7/ 11.2	16.0	17 01 154 1603 17 01 154 2603	
Type A CompactPCI hot swap Position P1	154	8.2/ 9.7/ 11.2	3.7	17 01 154 1204 17 01 154 2204	

Thin print part numbers: performance level 1
Bold print part numbers: performance level 2
 Connector dimensions see page 11.14

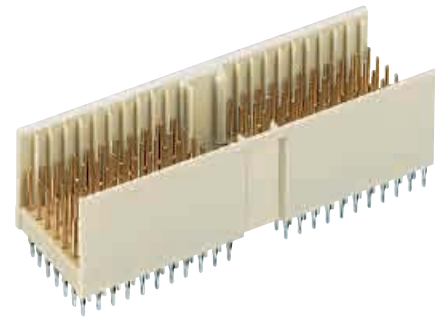

Male connectors, straight

Identification	Number of contacts	Contact length [mm] mating side	termination side	Part number	Contact configuration
Type A CompactPCI computer telephony Position P4	100	8.2/ 9.7/ 11.2	13.0/ 14.5/ 16.0	17 01 100 1001 17 01 100 2001	
Type A CompactPCI computer telephony Position P4	100	8.2/ 9.7/ 11.2	3.7	17 01 100 1201 17 01 100 2201	

Contact dimensions [mm]

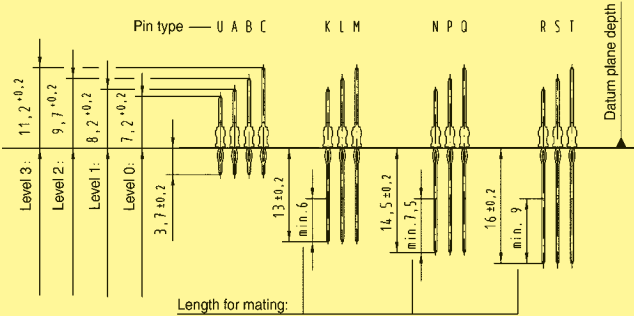

Connector dimensions [mm]

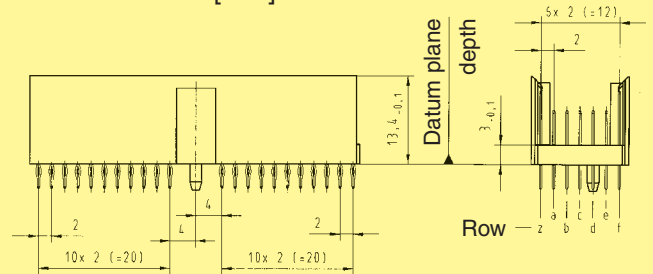

Position - 25

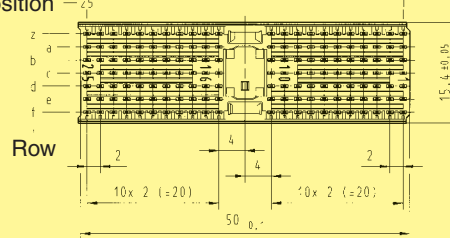

Board drillings

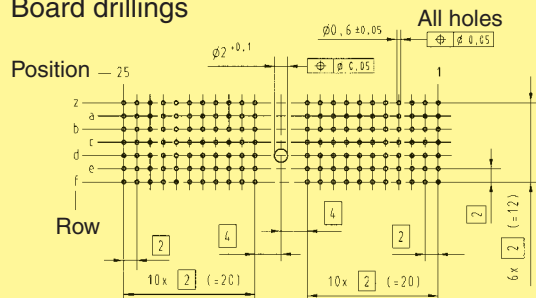

harbus[®] HM

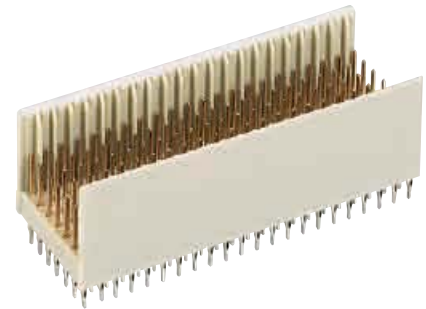

Male connectors, straight

Identification	Number of contacts	Contact length [mm] mating side	termination side	Part number	Contact configuration
Type B25	125	8.2	3.7	17 02 125 1201 17 02 125 2201	
Type B25	150	8.2/ 11.2	3.7	17 02 150 1201 17 02 150 2201	
Type B25	175	8.2/ 11.2	3.7	17 02 175 1201 17 02 175 2201	
Type B25	125	9.7/ 11.2	3.7	17 02 125 1205 17 02 125 2205	
Type B25	175	8.2/ 9.7/ 11.2	3.7	17 02 175 1202 17 02 175 2202	
Type B25	175	8.2/ 11.2	13.0/ 16.0	17 02 175 1006 17 02 175 2006	

harbus
HM

Thin print part numbers: performance level 1
Bold print part numbers: performance level 2
 Connector dimensions see page 11.18



Male connectors, straight

Identification	Number of contacts	Contact length [mm] mating side	Contact length [mm] termination side	Part number	Contact configuration
Type B22	110	8.2	3.7	17 04 110 1201 17 04 110 2201	
Type B22	154	8.2/ 11.2	3.7	17 04 154 1201 17 04 154 2201	
Type B22 CompactPCI Position P2	154	9.7/ 11.2	3.7	17 04 154 1203 17 04 154 2203	
Type B22 CompactPCI computer telephony	132	8.2/ 9.7/ 11.2	13.0/ 14.5/ 16.0	17 04 132 1001 17 04 132 2001	
Type B22 CompactPCI AB friendly	154	9.7/ 11.2	3.7/ 16.0	17 04 154 1010 17 04 154 2010	
Type B22 CompactPCI AB friendly	154	9.7/ 11.2	3.7/ 14.5/ 16.0	17 04 154 1002 17 04 154 2002	

harbus[®] HM

Thin print part numbers: performance level 1
Bold print part numbers: performance level 2
 Connector dimensions see page 11.18

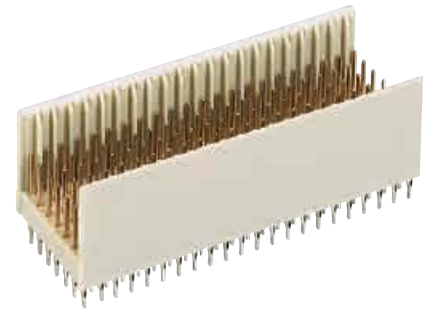

Male connectors, straight

Identification	Number of contacts	Contact length [mm] mating side	termination side	Part number	Contact configuration
Type B19 VME Position J0	95	8.2	3.7	17 05 095 1201 17 05 095 2201	
Type B19 VME Position J0	133	8.2/ 11.2	3.7	17 05 133 1201 17 05 133 2201	
Type B19 VME Position J0	133	9.7/ 11.2	3.7	17 05 133 1203 17 05 133 2203	
Type B19 VME Position J0	95	8.2	13.0	17 05 095 1401 17 05 095 2401	
Type B19 CompactPCI AB friendly Position P3	133	9.7/ 11.2	3.7/ 16.0	17 05 133 1005 17 05 133 2005	
Type B19 Compact PCI Position P3 VME Position J0	133	8.2/ 11.2	16.0	17 05 133 1602 17 05 133 2602	

harbus
HM

Thin print part numbers: performance level 1
Bold print part numbers: performance level 2
 Connector dimensions see page 11.18

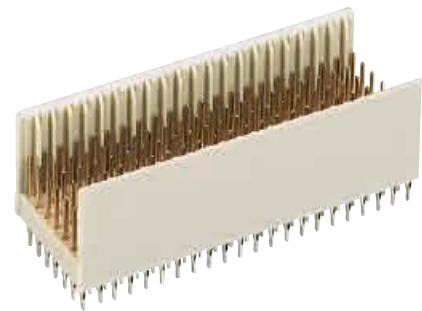

Male connectors, straight

Drawing

Dimensions in mm

Contact dimensions [mm]

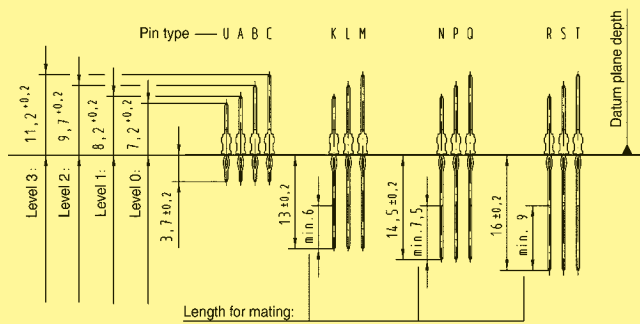

Connector dimensions [mm]

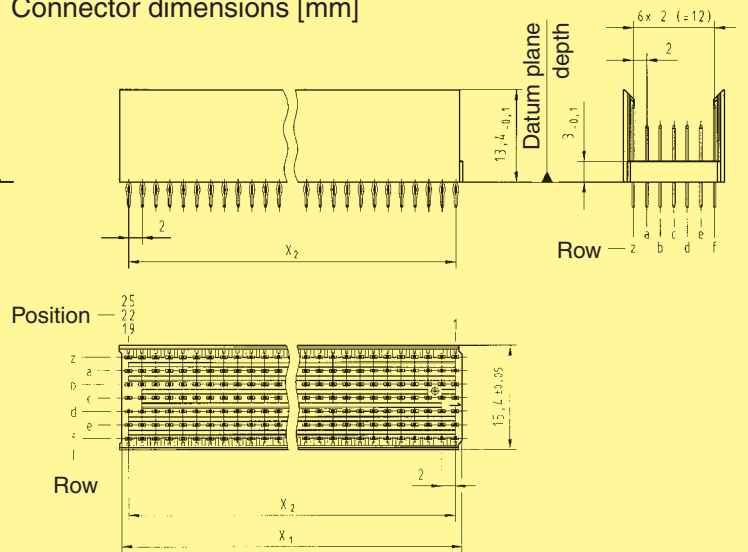

Board drillings

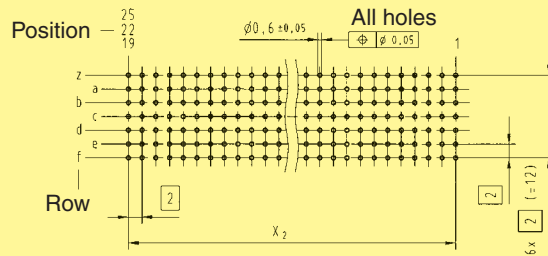

Contact positions	x ₁	x ₂
19	37.9	18 x 2 (= 36)
22	43.9	21 x 2 (= 42)
25	49.9	24 x 2 (= 48)

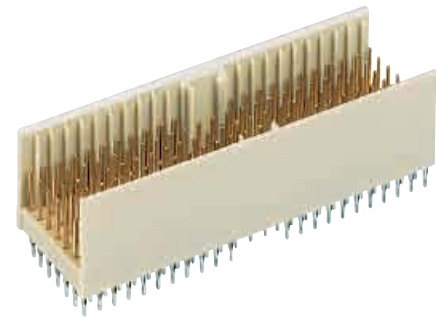

Male connectors, straight

Identification	Number of contacts	Contact length [mm] mating side	termination side	Part number	Contact configuration
Type AB ₂₅	125	8.2	3.7	17 15 125 1201 17 15 125 2201	
Type AB ₂₅	169	8.2/ 11.2	3.7	17 15 169 1201 17 15 169 2201	
Type AB ₂₅	169	8.2/ 11.2	13.0/ 16.0	17 15 169 1003 17 15 169 2003	

Contact dimensions [mm]

Connector dimensions [mm]

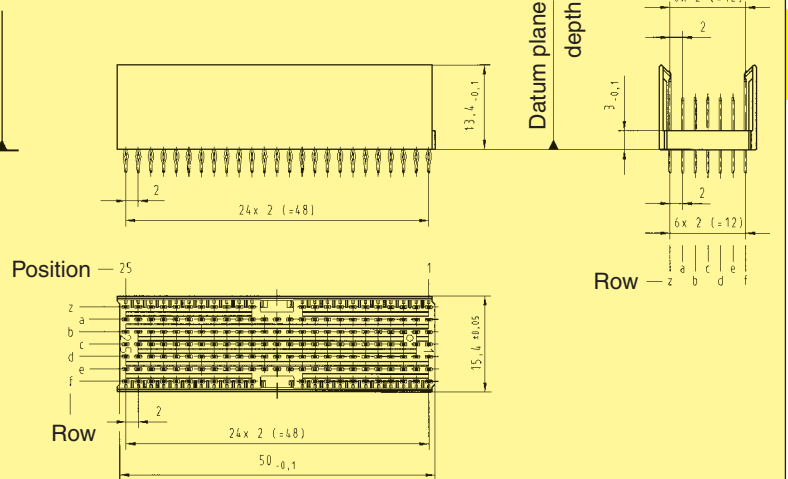
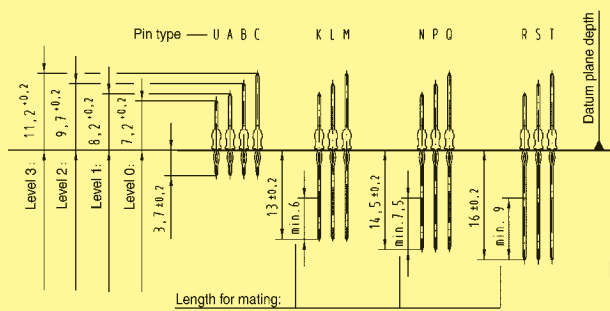

Board drillings

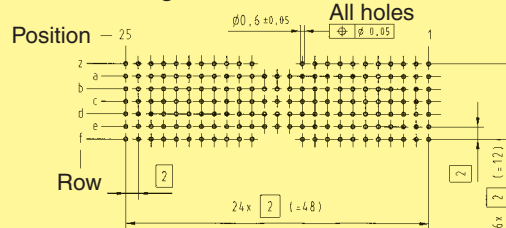

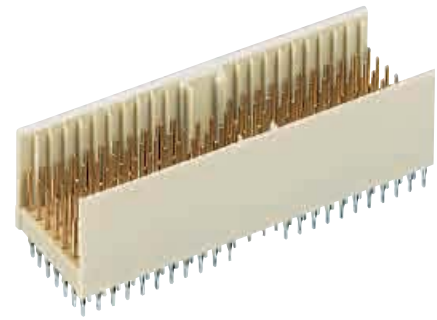

Male connectors, straight

Identification	Number of contacts	Contact length [mm] mating side	Contact length [mm] termination side	Part number	Contact configuration
Type AB ₂₂	110	8.2	3.7	17 14 110 1201 17 14 110 2201	
Type AB ₂₂	146	8.2/ 11.2	3.7	17 14 146 1201 17 14 146 2201	
Type AB ₂₂	146	9.7/ 11.2	16.0	17 14 146 1601 17 14 146 2601	

Contact dimensions [mm]

Connector dimensions [mm]

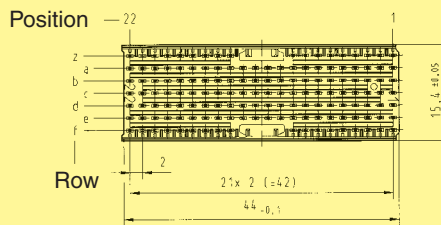
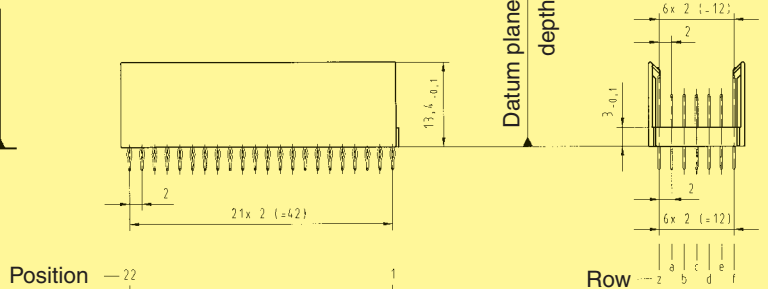
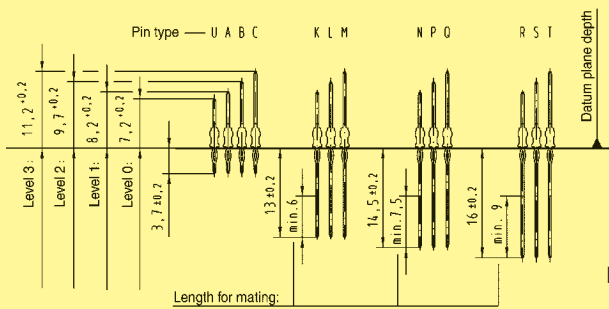

Board drillings

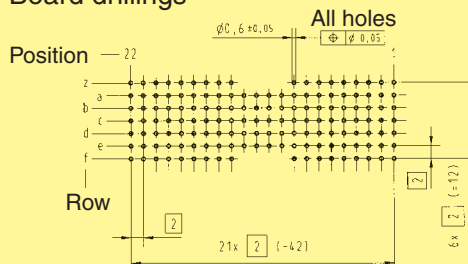

harbus[®] HM

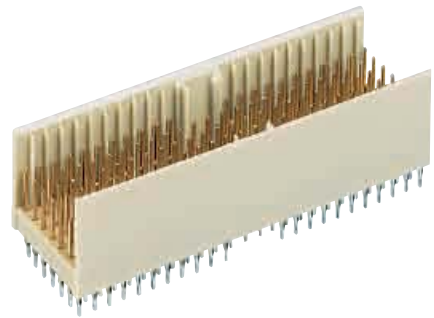

Male connectors, straight

Identification	Number of contacts	Contact length [mm] mating side	termination side	Part number	Contact configuration
Type AB19	95	8.2	3.7	17 13 095 1201 17 13 095 2201	
Type AB19	127	8.2/ 11.2	3.7	17 13 127 1201 17 13 127 2201	
Type AB19	127	9.7/ 11.2	16.0	17 13 127 1601 17 13 127 2601	

Contact dimensions [mm]

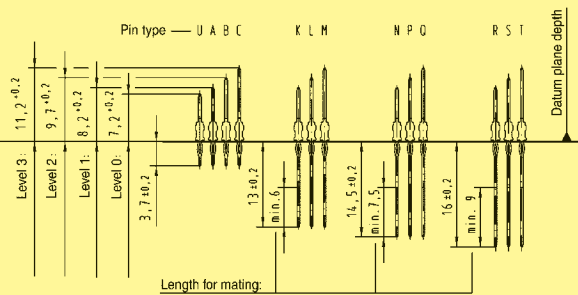

Connector dimensions [mm]

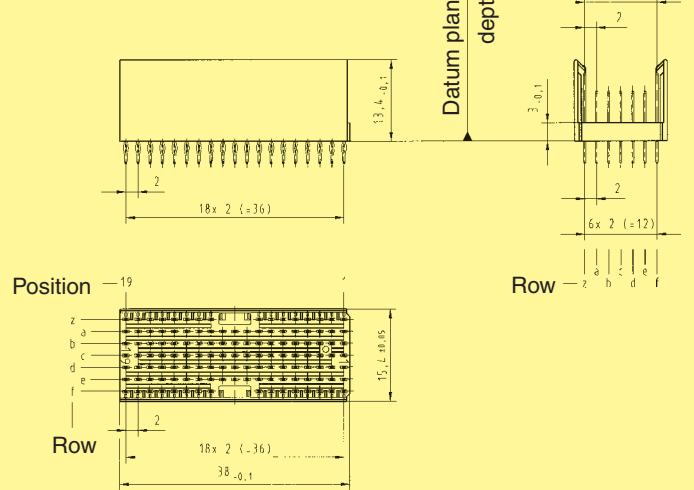

Board drillings

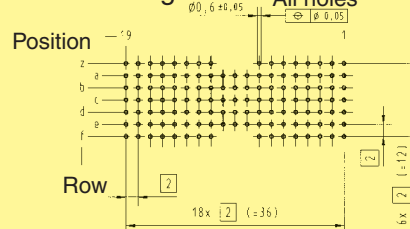

harbus[®] HM

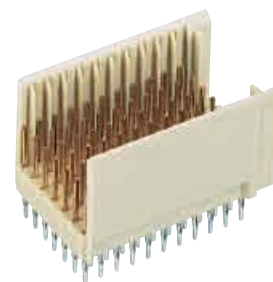

Male connectors, straight

Identification	Number of contacts	Contact length [mm] mating side	termination side	Part number	Contact configuration
Type C	55	8.2	3.7	17 03 055 1201 17 03 055 2201	<p>Diagram showing a 5x11 grid of contacts labeled 'A'. The columns are numbered 11 to 1 from right to left. The rows are labeled 'z' through 'f' from top to bottom. A side view diagram shows the contact profile.</p>
Type C	77	8.2/ 11.2	3.7	17 03 077 1201 17 03 077 2201	<p>Diagram showing a 5x15 grid of contacts. The first 11 columns are labeled 'A' and the last 6 columns are labeled 'C'. The columns are numbered 11 to 1 from right to left. The rows are labeled 'z' through 'f' from top to bottom. A side view diagram shows the contact profile.</p>
Type C	55	9.7	3.7	17 03 055 1202 17 03 055 2202	<p>Diagram showing a 5x11 grid of contacts labeled 'B'. The columns are numbered 11 to 1 from right to left. The rows are labeled 'z' through 'f' from top to bottom. A side view diagram shows the contact profile.</p>
Type C	77	9.7/ 11.2	3.7	17 03 077 1202 17 03 077 2202	<p>Diagram showing a 5x15 grid of contacts. The first 11 columns are labeled 'B' and the last 6 columns are labeled 'C'. The columns are numbered 11 to 1 from right to left. The rows are labeled 'z' through 'f' from top to bottom. A side view diagram shows the contact profile.</p>
Type C	55	8.2	13.0	17 03 055 1401 17 03 055 2401	<p>Diagram showing a 5x11 grid of contacts labeled 'K'. The columns are numbered 11 to 1 from right to left. The rows are labeled 'z' through 'f' from top to bottom. A side view diagram shows the contact profile.</p>
Type C	66	8.2/ 11.2	13.0/ 16.0	17 03 066 1001 17 03 066 2001	<p>Diagram showing a 5x13 grid of contacts. The first 11 columns are labeled 'K' and the last 2 columns are labeled 'T'. The columns are numbered 11 to 1 from right to left. The rows are labeled 'z' through 'f' from top to bottom. A side view diagram shows the contact profile.</p>

harbus[®] HM

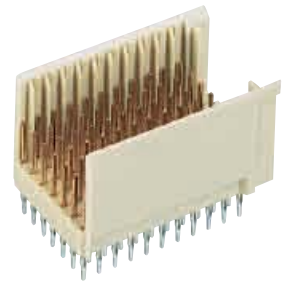

Male connectors, straight

Identification	Number of contacts	Contact length [mm] mating side	termination side	Part number	Contact configuration
Type C	77	8.2/ 11.2	3.7/ 13.0	17 03 077 1001 17 03 077 2001	
Type C	77	8.2/ 11.2	16.0	17 03 077 1601 17 03 077 2601	

Contact dimensions [mm]

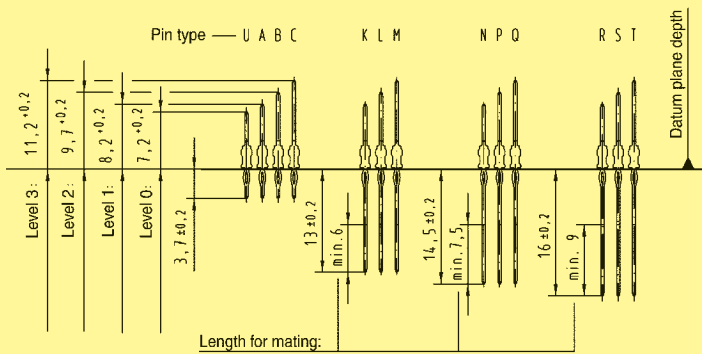

Connector dimensions [mm]

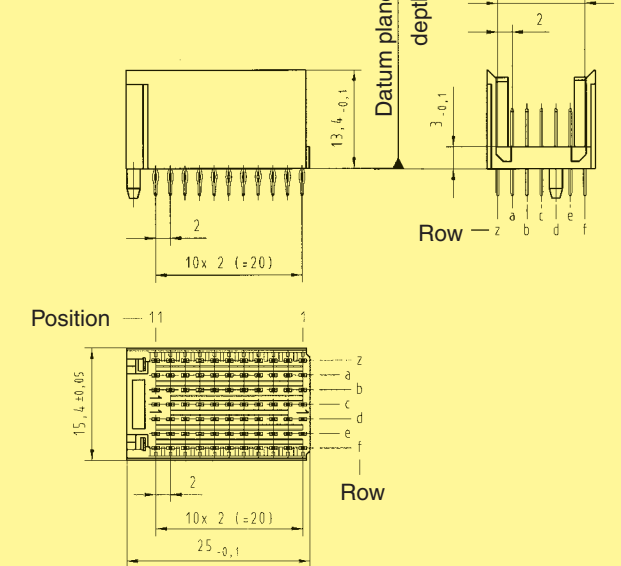

Board drillings

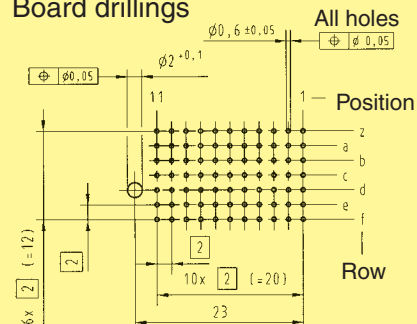

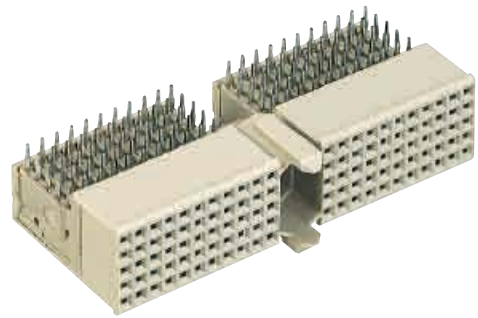

Female connectors, angled

Identification	No. of contacts	Contact length [mm] termination side	Part number
Type A	110	3.4	17 21 110 1101 17 21 110 2101
Type A with upper shield CompactPCI Positions J1, J4	110	3.4	17 21 110 1102 17 21 110 2102
Lower shield for type A connectors			17 21 000 4102
Type A with split upper shield CompactPCI computer telephony Position J4	90	3.4	17 21 090 1103 17 21 090 2103
Lower shield for type A connectors (rows 1 – 5) CompactPCI computer telephony			17 29 000 4102
Lower shield for type A connectors (rows 15 – 25) CompactPCI computer telephony			17 23 000 4102

harbus
HM

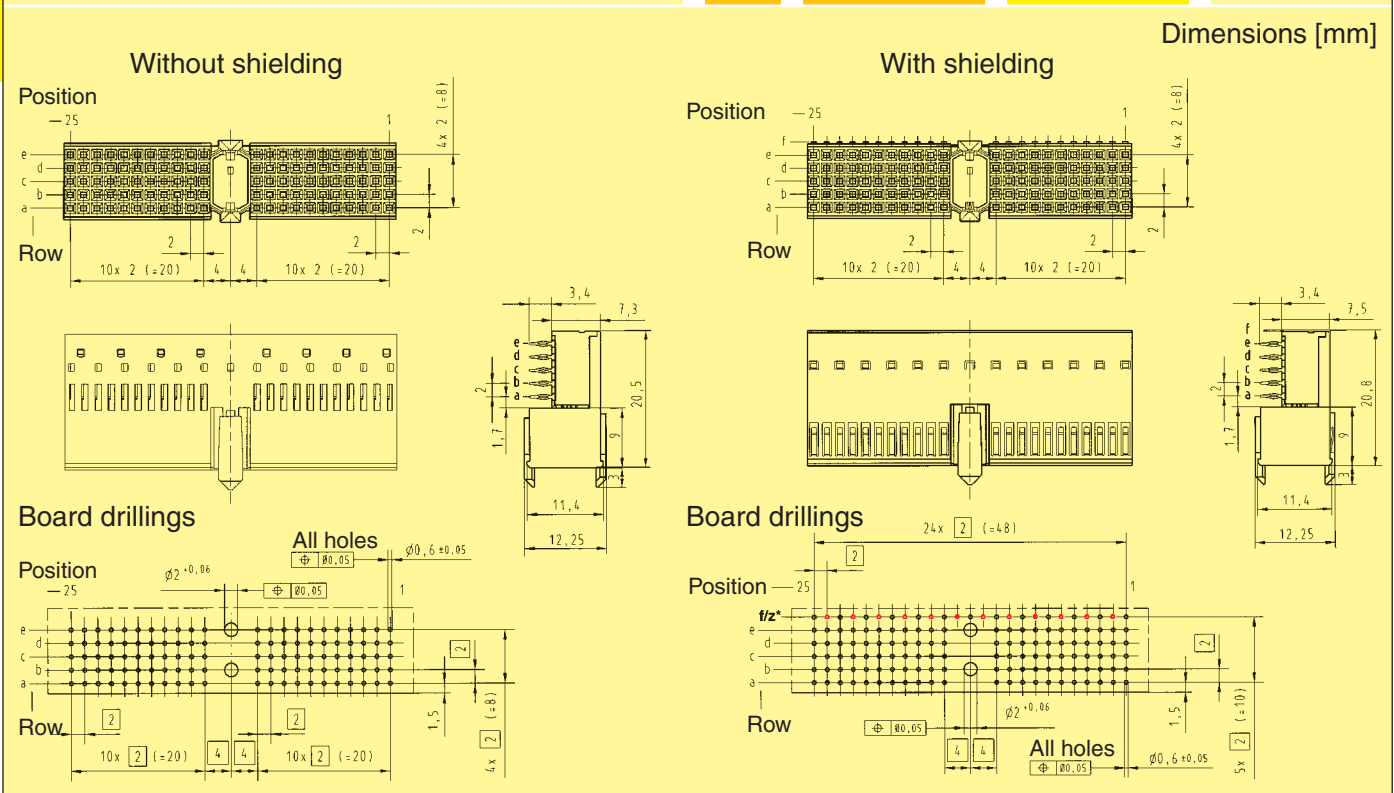

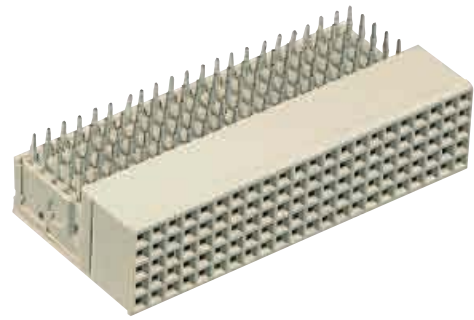

Female connectors, angled

Identification	No. of contacts	Contact length [mm] termination side	Part number
Type B19 VME, Position P0	95	3.4	17 25 095 1101 17 25 095 2101
Type B19 with upper shield CompactPCI, Position J3 – VME, Position P0	95	3.4	17 25 095 1102 17 25 095 2102
Lower shield for type B19 connectors			17 25 000 4102
Type B22	110	3.4	17 24 110 1101 17 24 110 2101
Type B22 with upper shield CompactPCI, Positions J2, J5	110	3.4	17 24 110 1102 17 24 110 2102
Lower shield for type B22 connectors			17 24 000 4102
Type B25	125	3.4	17 22 125 1101 17 22 125 2101
Type B25 with upper shield	125	3.4	17 22 125 1102 17 22 125 2102
Lower shield for type B25 connectors			17 22 000 4102

Contact positions	X ₁	X ₂
19	37.9	18 x 2 (= 36)
22	43.9	21 x 2 (= 42)
25	49.9	24 x 2 (= 48)

Dimensions [mm]

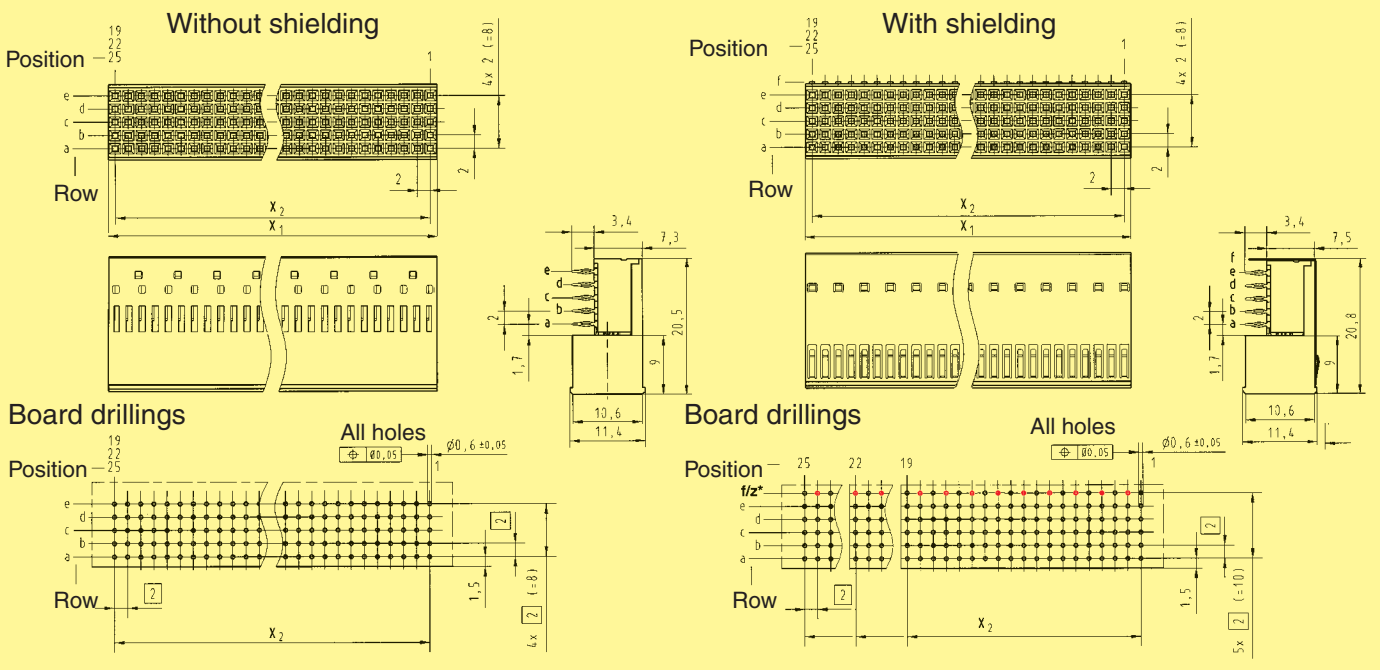

Thin print part numbers: performance level 1
Bold print part numbers: performance level 2

* hole on even contact numbers only needed for lower shielding

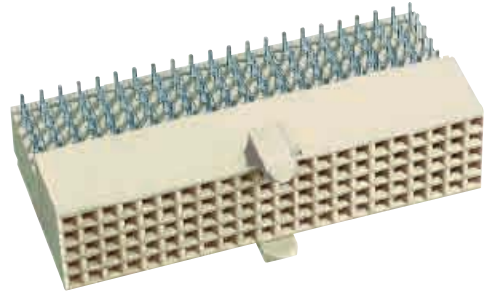

Female connectors, angled

Identification	No. of contacts	Contact length [mm] termination side	Part number
Type AB ₁₉	95	3.4	17 33 095 1101 17 33 095 2101
Type AB ₁₉ with upper shield CompactPCI, Position RJ3	95	3.4	17 33 095 1102 17 33 095 2102
Lower shield for type AB ₁₉ connectors			17 33 000 4102
Type AB ₂₂	110	3.4	17 34 110 1101 17 34 110 2101
Type AB ₂₂ with upper shield CompactPCI, Positions RJ2, RJ5	110	3.4	17 34 110 1102 17 34 110 2102
Lower shield for type AB ₂₂ connectors			17 34 000 4102
Type AB ₂₅	125	3.4	17 35 125 1101 17 35 125 2101
Type AB ₂₅ with upper shield	125	3.4	17 35 125 1102 17 35 125 2102
Lower shield for type AB ₂₅ connectors			17 21 000 4102

Contact positions	x ₁	x ₂
19	37.9	18 x 2 (= 36)
22	43.9	21 x 2 (= 42)
25	49.9	24 x 2 (= 48)

Dimensions [mm]

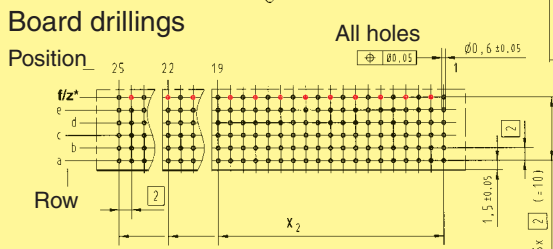
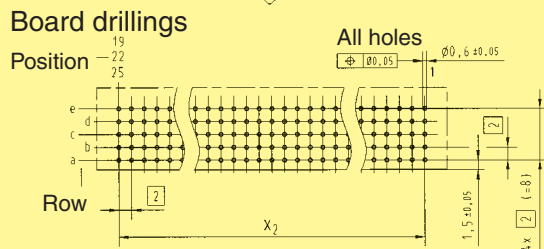
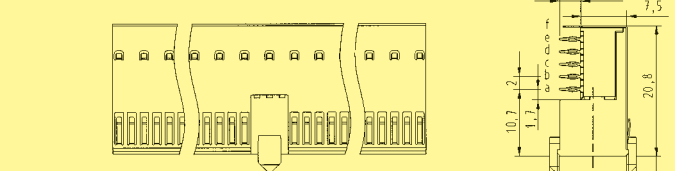
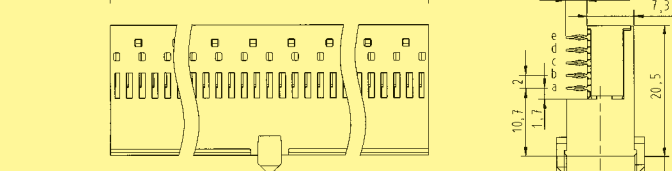
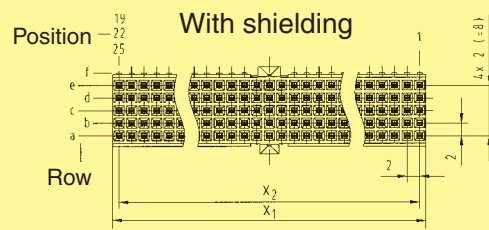
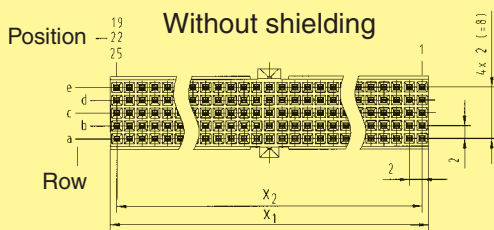

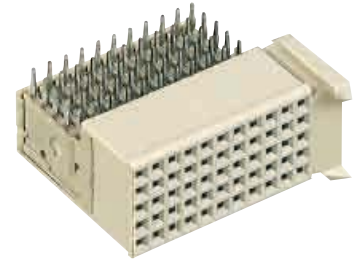

Female connectors, angled

Identification	No. of contacts	Contact length [mm] termination side	Part number
Type C	55	3.4	17 23 055 1101 17 23 055 2101
Type C with upper shield	55	3.4	17 23 055 1102 17 23 055 2102
Lower shield for type C connectors			17 23 000 4102

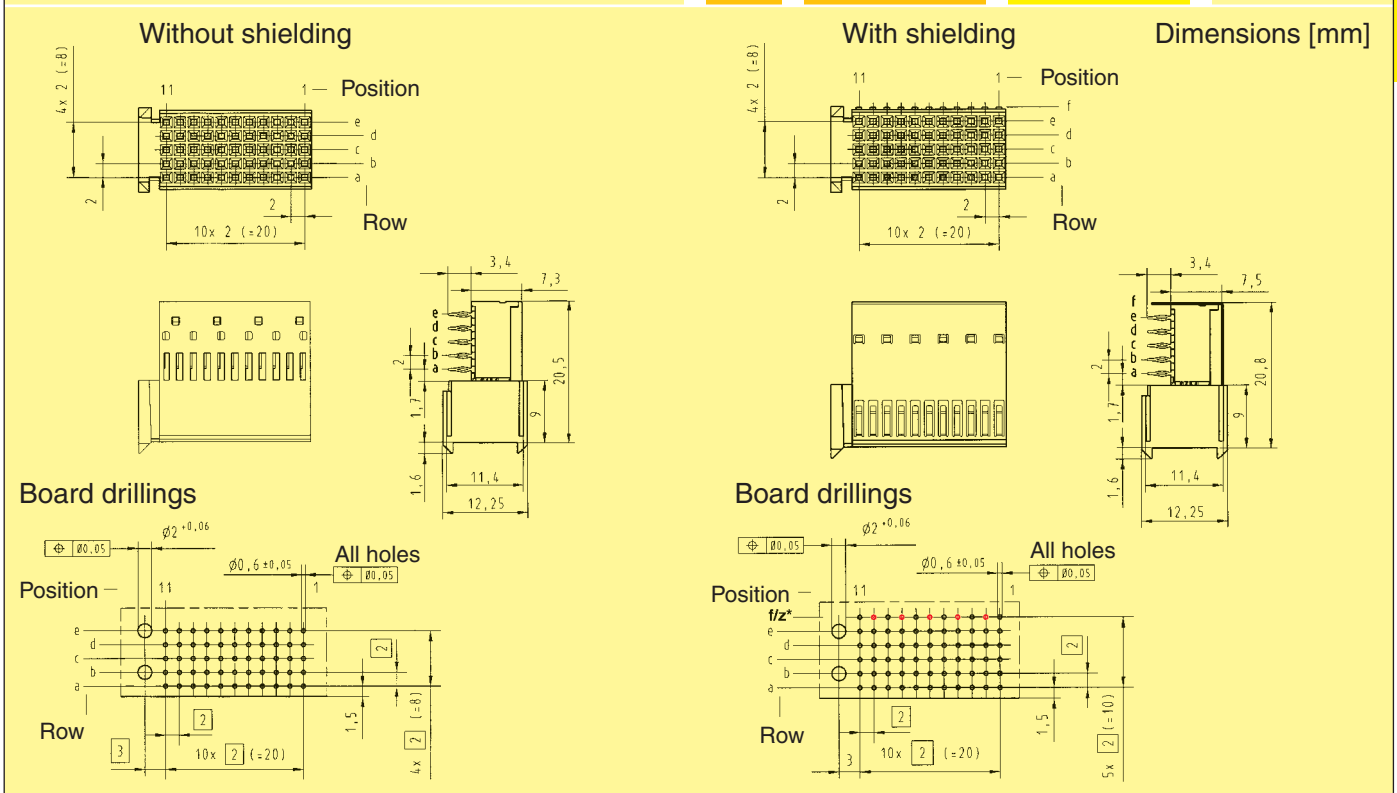

Thin print part numbers: performance level 1
Bold print part numbers: performance level 2

* hole on even contact numbers only needed for lower shielding

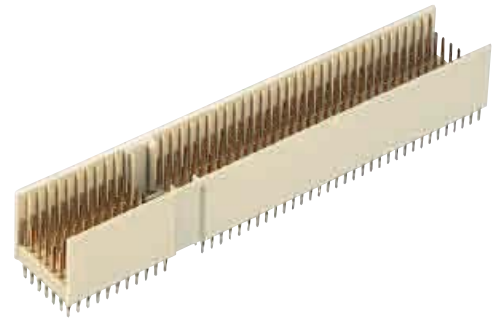

Male connectors, straight

Identification	Number of contacts	Contact length [mm] mating side	termination side	Part number	Contact configuration
Type Monoblock 47	220	8.2	3.7	17 06 220 1201 17 06 220 2201	
Type Monoblock 47	308	8.2/ 11.2	3.7	17 06 308 1201 17 06 308 2201	
Type Monoblock 47	220	9.7	3.7	17 06 220 1202 17 06 220 2202	
Type Monoblock 47 CompactPCI Positions P1 and P2	308	8.2/ 9.7/ 11.2	3.7	17 06 308 1202 17 06 308 2202	
Type Monoblock 47 CompactPCI hot swap	308	8.2/ 9.7/ 11.2	3.7	17 06 308 1203 17 06 308 2203	
Type Monoblock 47 CompactPCI computer telephony	232	8.2/ 9.7/ 11.2	3.7	17 06 232 1201 17 06 232 2201	

harbus
HM

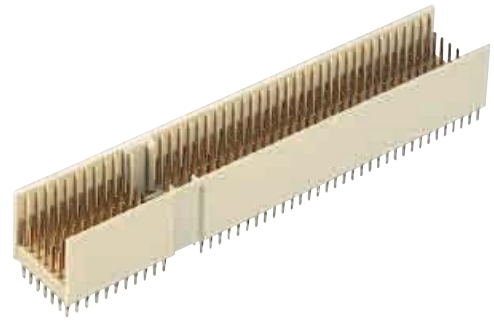

Male connectors, straight

Identification	Number of contacts	Contact length [mm] mating side	termination side	Part number	Contact configuration
Type Monoblock 47 CompactPCI I/O	308	8.2/ 9.7/ 11.2	3.7/ 16.0	17 06 308 1001 17 06 308 2001	
Type Monoblock 47 CompactPCI AB friendly Positions P4 and P5	308	9.7/ 11.2	3.7/ 16.0	17 06 308 1005 17 06 308 2005	

Contact dimensions [mm]

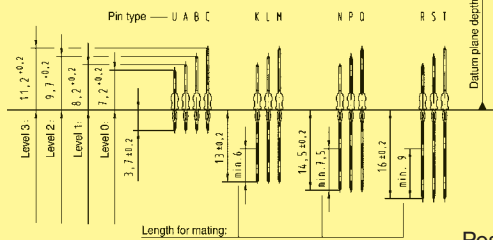

Connector dimensions [mm]

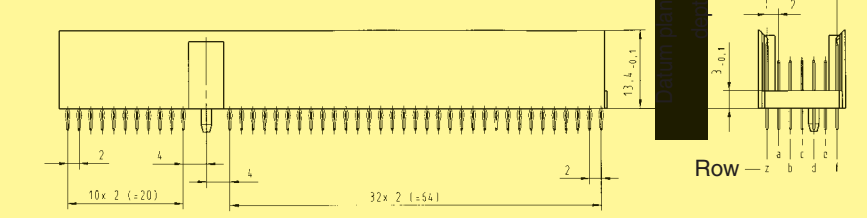

Position

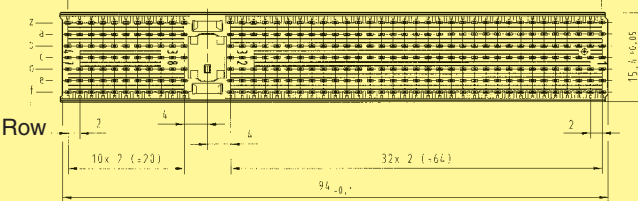

Board drillings

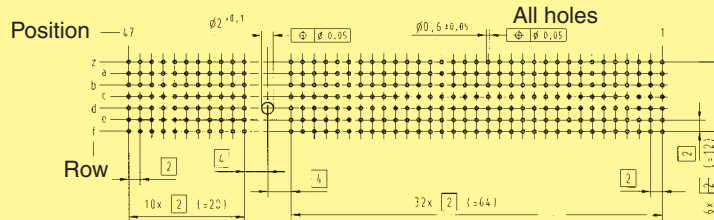

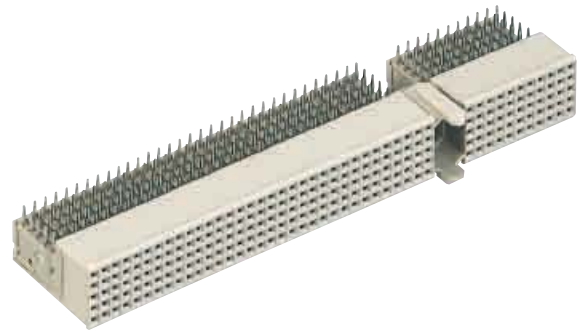

Female connectors, angled

Identification	No. of contacts	Contact length [mm] termination side	Part number
Type Monoblock 47	220	3.4	17 26 220 1101 17 26 220 2101
Type Monoblock 47 with upper shield	220	3.4	17 26 220 1102 17 26 220 2102
Type Monoblock 47 with upper shield CompactPCI computer telephony	200	3.4	17 26 200 1103 17 26 200 2103
Lower shield for type Monoblock 47 connectors			17 26 000 4102
Lower shield for type Monoblock 47 connectors (rows 1 – 22) CompactPCI computer telephony			17 24 000 4102
Lower shield for type Monoblock 47 connectors (rows 23 – 27) CompactPCI computer telephony			17 29 000 4102
Lower shield for type Monoblock 47 connectors (rows 37 – 47) CompactPCI computer telephony			17 23 000 4102

Without shielding

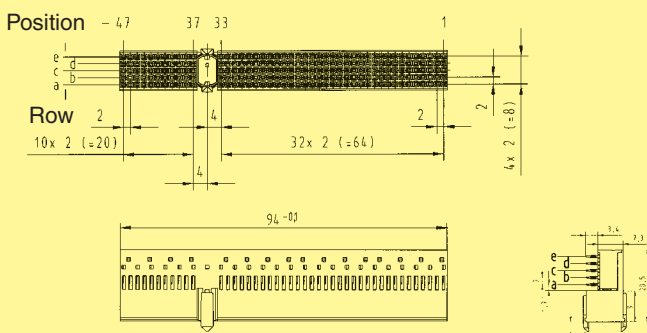

With shielding

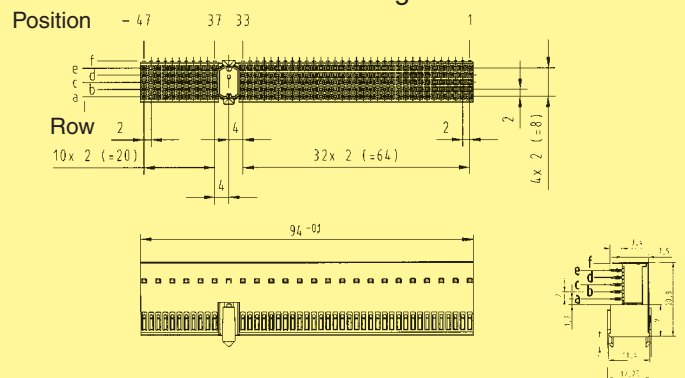

Board drillings

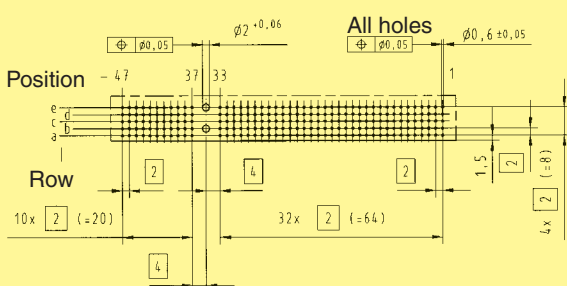

Board drillings

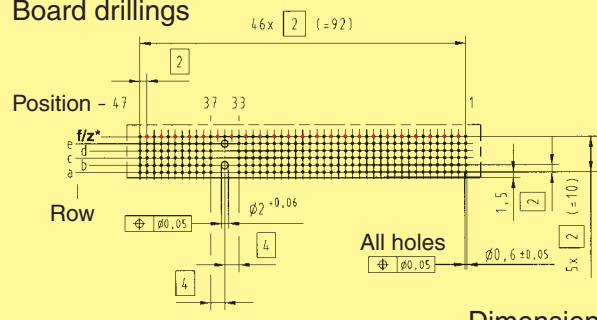

Dimensions [mm]

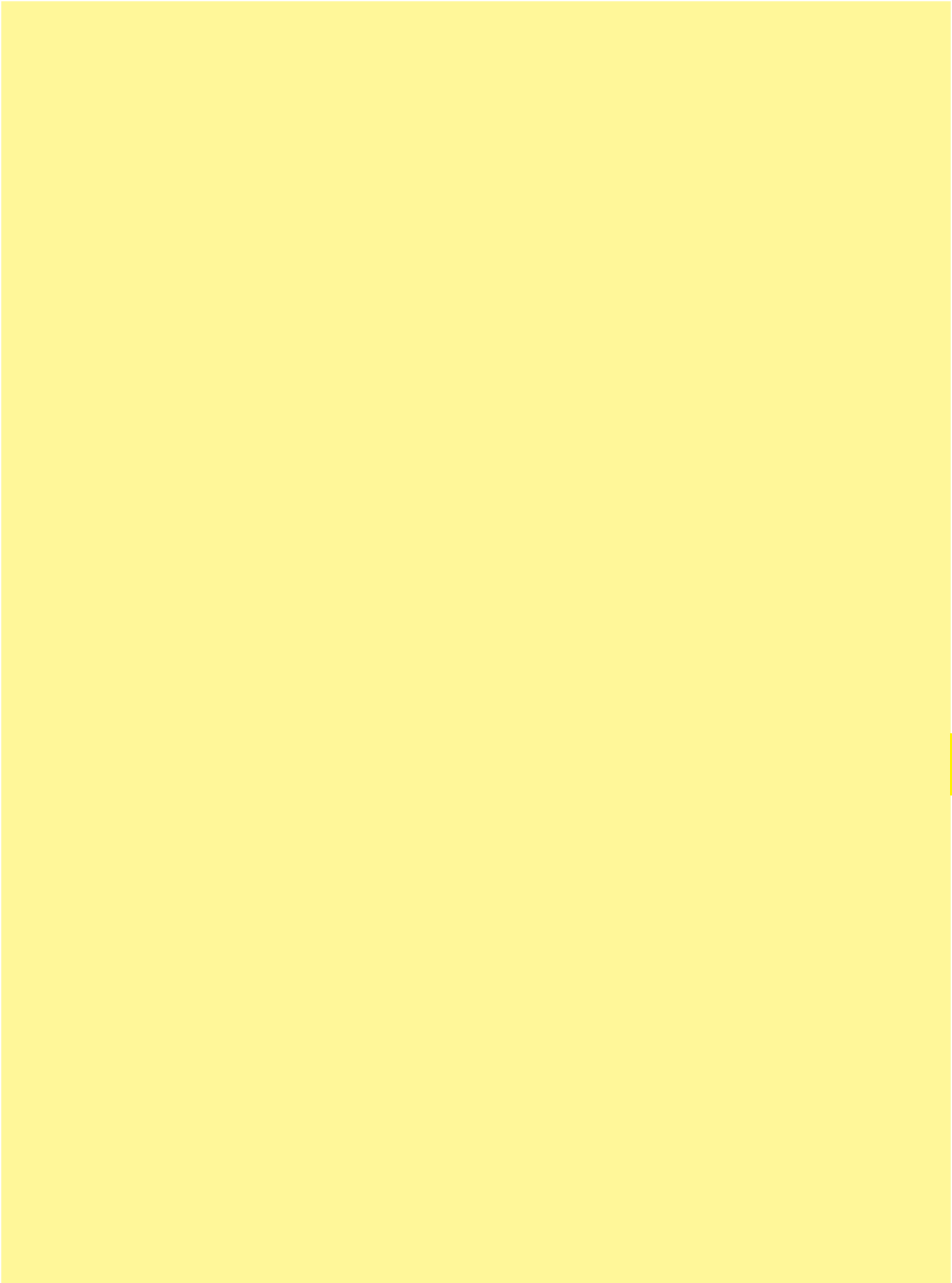

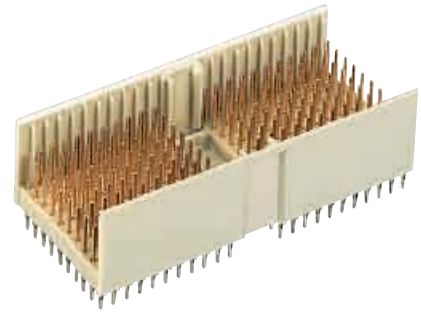

Male connectors, straight

Identification	Number of contacts	Contact length [mm] mating side	termination side	Part number	Contact configuration
Type D	176	8.2	3.7	17 11 176 1201 17 11 176 2201	
Type D	220	8.2/ 11.2	3.7	17 11 220 1201 17 11 220 2201	
Type D	220	9.7/ 11.2	14.5/ 16.0	17 11 220 1001 17 11 220 2001	

Contact dimensions [mm]

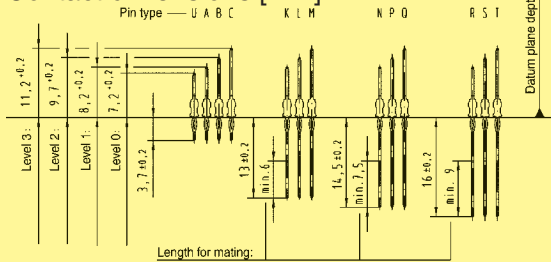

Connector dimensions [mm]

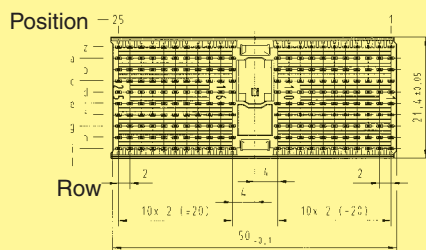
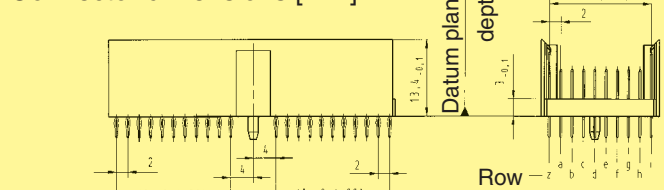

Board drillings

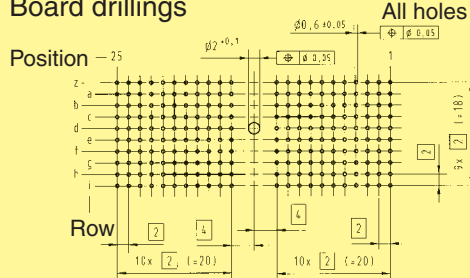

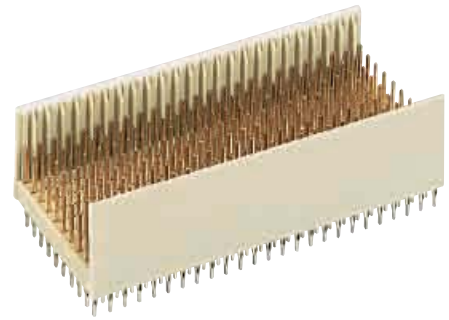

Male connectors, straight

Identification	Number of contacts	Contact length [mm] mating side	termination side	Part number	Contact configuration
Type E	200	8.2	3.7	17 12 200 1201 17 12 200 2201	
Type E	250	8.2/ 11.2	3.7	17 12 250 1201 17 12 250 2201	
Type E	250	9.7/ 11.2	14.5/ 16.0	17 12 250 1001 17 12 250 2001	

Contact dimensions [mm]

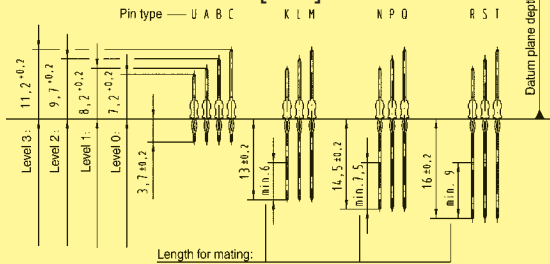

Connector dimensions [mm]

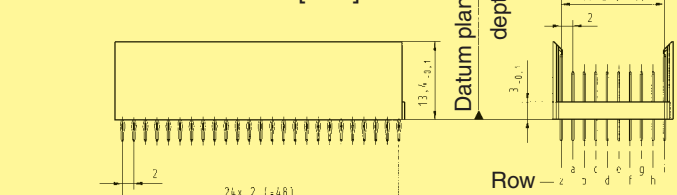

Position

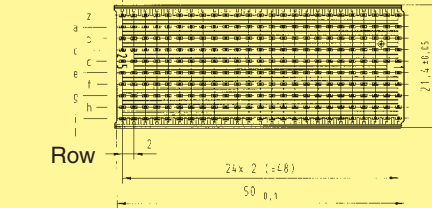

Board drillings

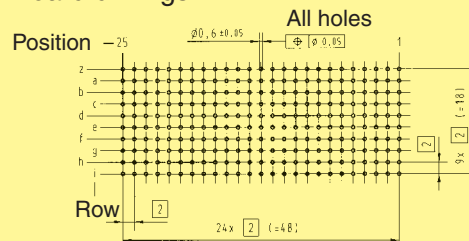

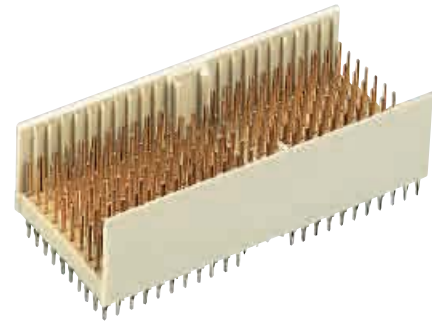

Male connectors, straight

Identification	Number of contacts	Contact length [mm] mating side	termination side	Part number	Contact configuration
Type DE	200	8.2	3.7	17 10 200 1201 17 10 200 2201	
Type DE	244	8.2/ 11.2	3.7	17 10 244 1201 17 10 244 2201	
Type DE	244	9.7/ 11.2	14.5/ 16.0	17 10 244 1001 17 10 244 2001	

Contact dimensions [mm]

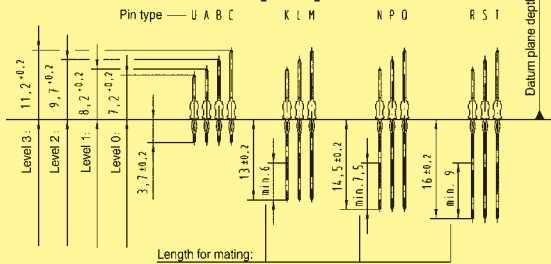

Connector dimensions [mm]

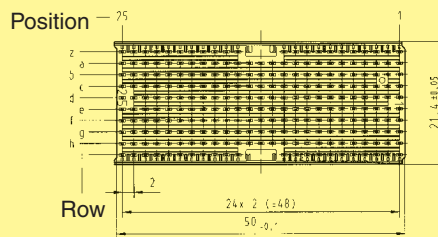
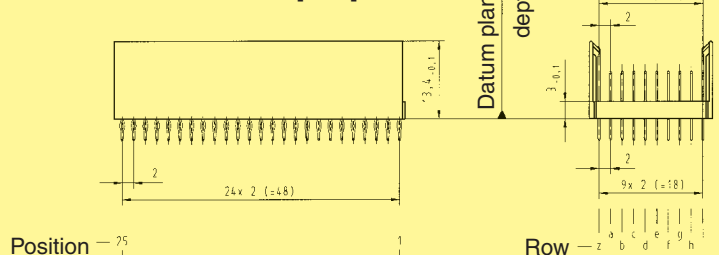

Board drillings

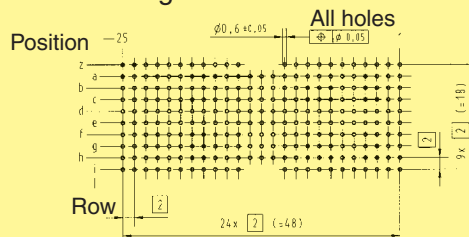

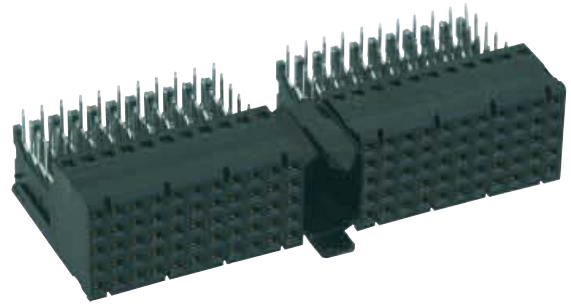

Female connectors, angled

Identification	No. of contacts	Contact length [mm] termination side	Part number
Type A	110	2.5	17 21 110 1801
Type A with upper shield	110	2.5	17 21 110 1802

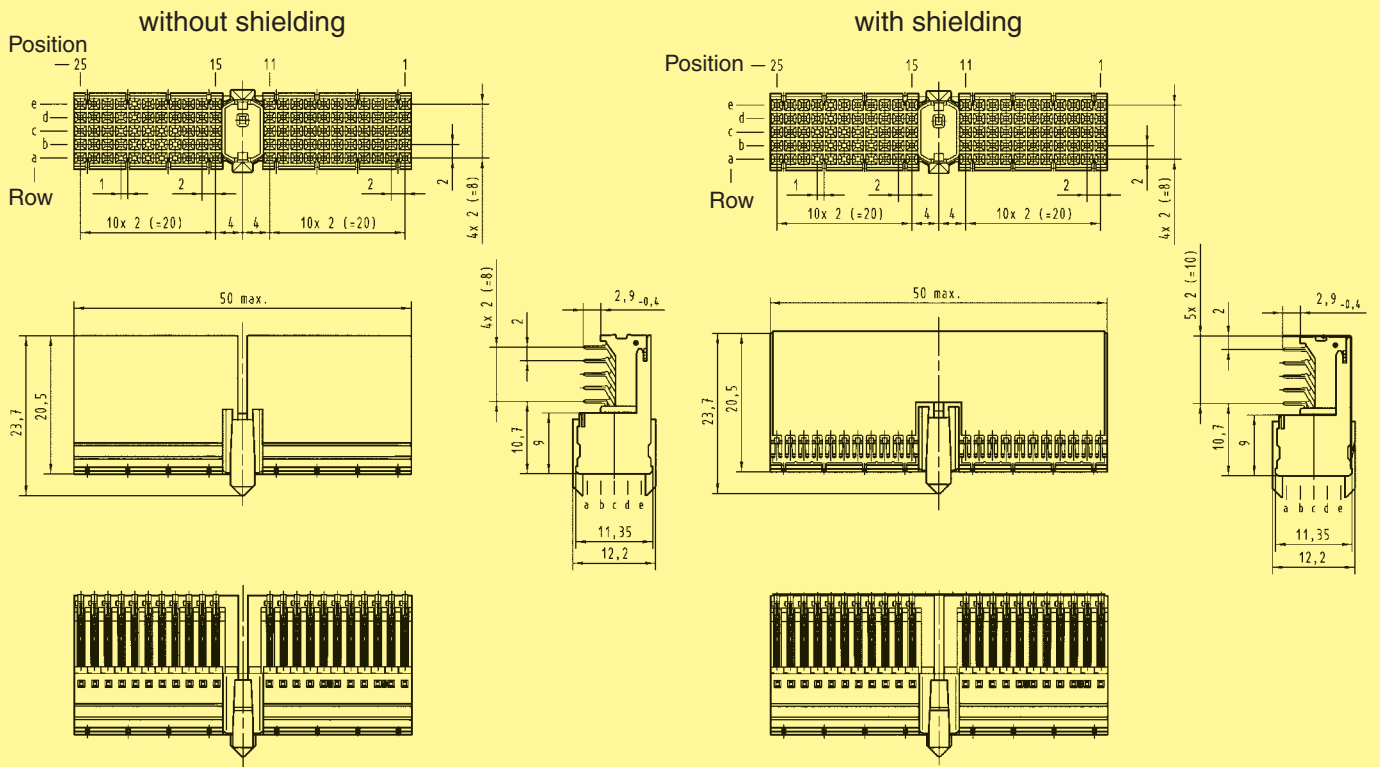

Board drillings

Diameter of drillings: $\varnothing 0.7 \pm 0.025$ mm
 Diameter of plated through holes: $\varnothing 0.6 \pm 0.050$ mm

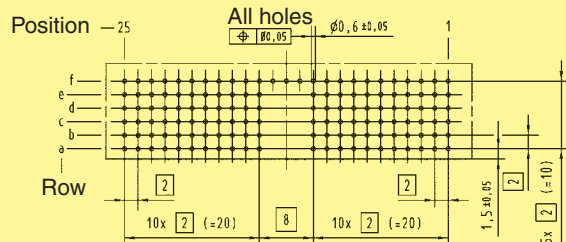
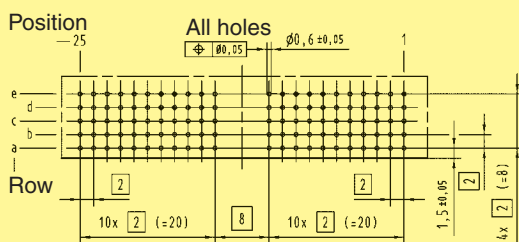

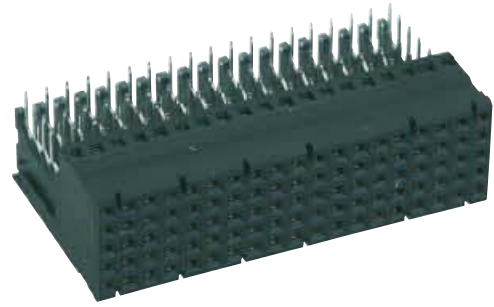

Female connectors, angled

Identification	No. of contacts	Contact length [mm] termination side	Part number
Type B ₁₉	95	2.5	17 25 095 1801
Type B ₁₉ with upper shield	95	2.5	17 25 095 1802
Type B ₂₂	110	2.5	17 24 110 1801
Type B ₂₂ with upper shield	110	2.5	17 24 110 1802
Type B ₂₅	125	2.5	17 22 125 1801
Type B ₂₅ with upper shield	125	2.5	17 22 125 1802

without shielding

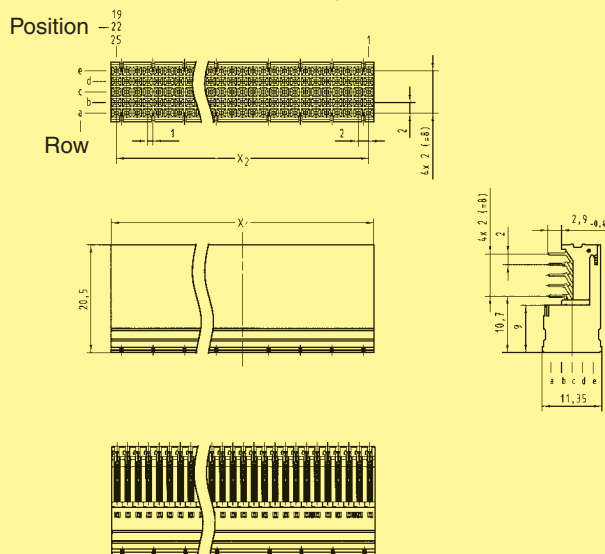

with shielding

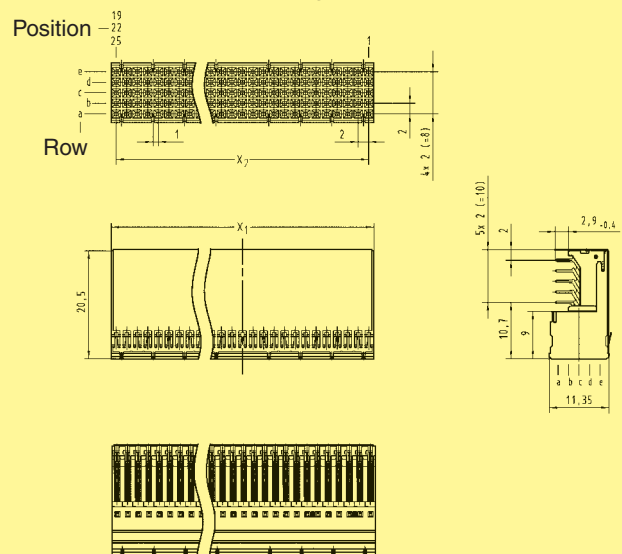

Board drillings

Diameter of drillings: $\varnothing 0.7 \pm 0.025$ mm
 Diameter of plated through holes: $\varnothing 0.6 \pm 0.050$ mm

Contact positions	X ₁	X ₂
19	38	18 x 2 (= 36)
22	44	21 x 2 (= 42)
25	50	24 x 2 (= 48)

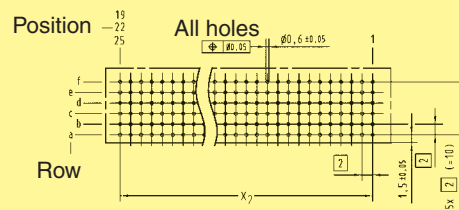
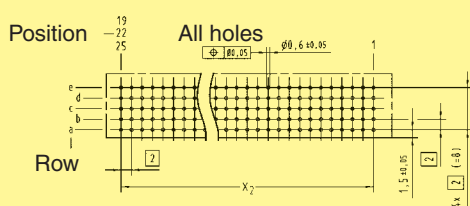



Female connectors, angled

Identification	No. of contacts	Contact length [mm] termination side	Part number
Type AB ₁₉	95	2.5	17 33 095 1801
Type AB ₁₉ with upper shield	95	2.5	17 33 095 1802
Type AB ₂₂	110	2.5	17 34 110 1801
Type AB ₂₂ with upper shield	110	2.5	17 34 110 1802
Type AB ₂₅	125	2.5	17 35 125 1801
Type AB ₂₅ with upper shield	125	2.5	17 35 125 1802

without shielding

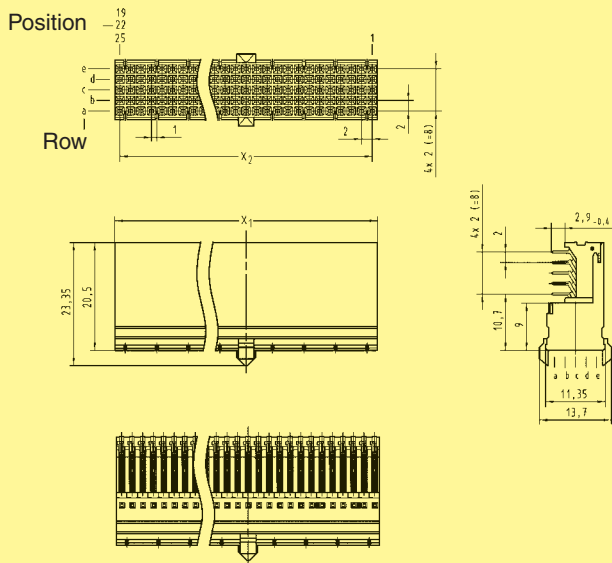

with shielding

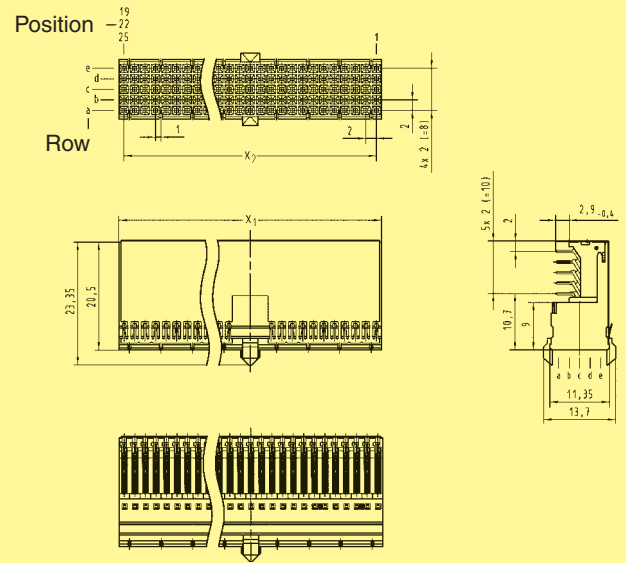

Board drillings

Diameter of drillings: $\varnothing 0.7 \pm 0.025$ mm
 Diameter of plated through holes: $\varnothing 0.6 \pm 0.050$ mm

Contact positions	X ₁	X ₂
19	38	18 x 2 (= 36)
22	44	21 x 2 (= 42)
25	50	24 x 2 (= 48)

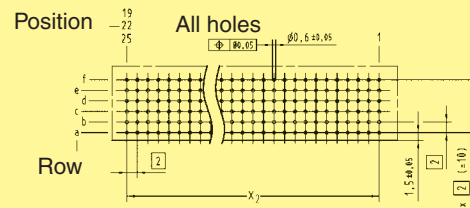
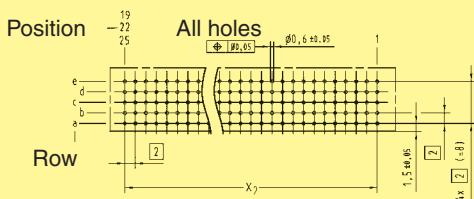

Dimensions [mm]

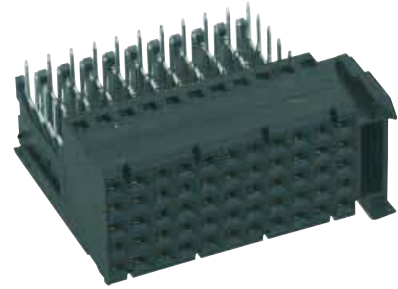

Female connectors, angled

Identification	No. of contacts	Contact length [mm] termination side	Part number
Type C	55	2.5	17 23 055 1801
Type C with upper shield	55	2.5	17 23 055 1802

without shielding

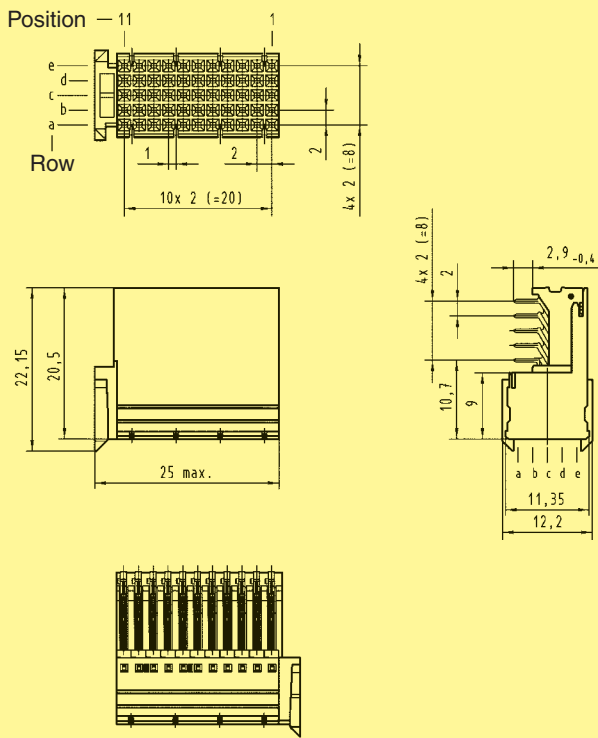

with shielding

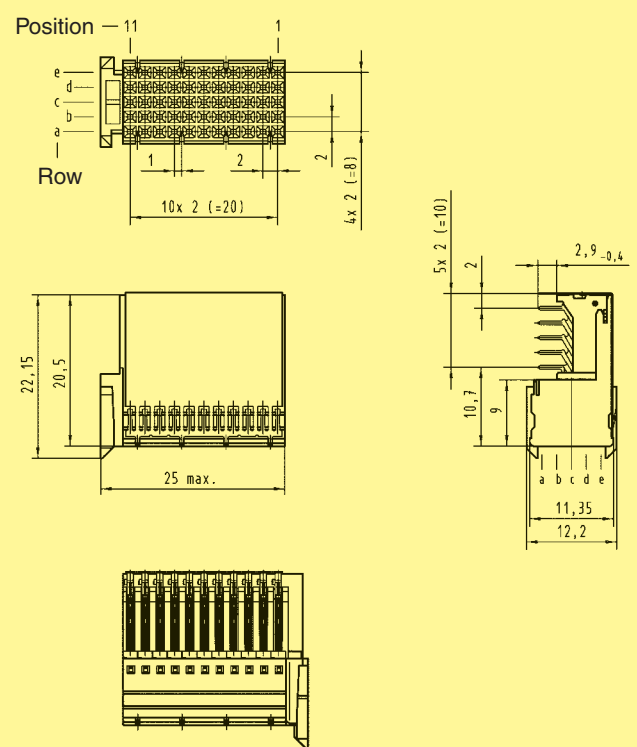

Board drillings

Diameter of drillings: $\varnothing 0.7 \pm 0.025$ mm

Diameter of plated through holes: $\varnothing 0.6 \pm 0.050$ mm

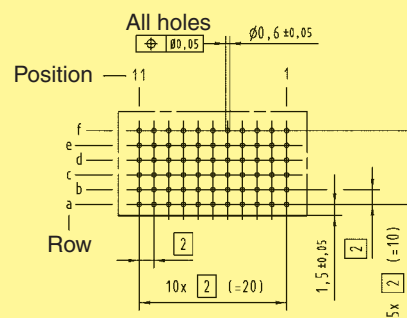
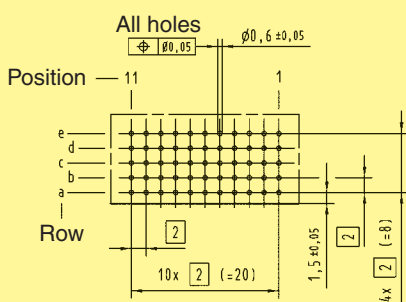

Dimensions [mm]

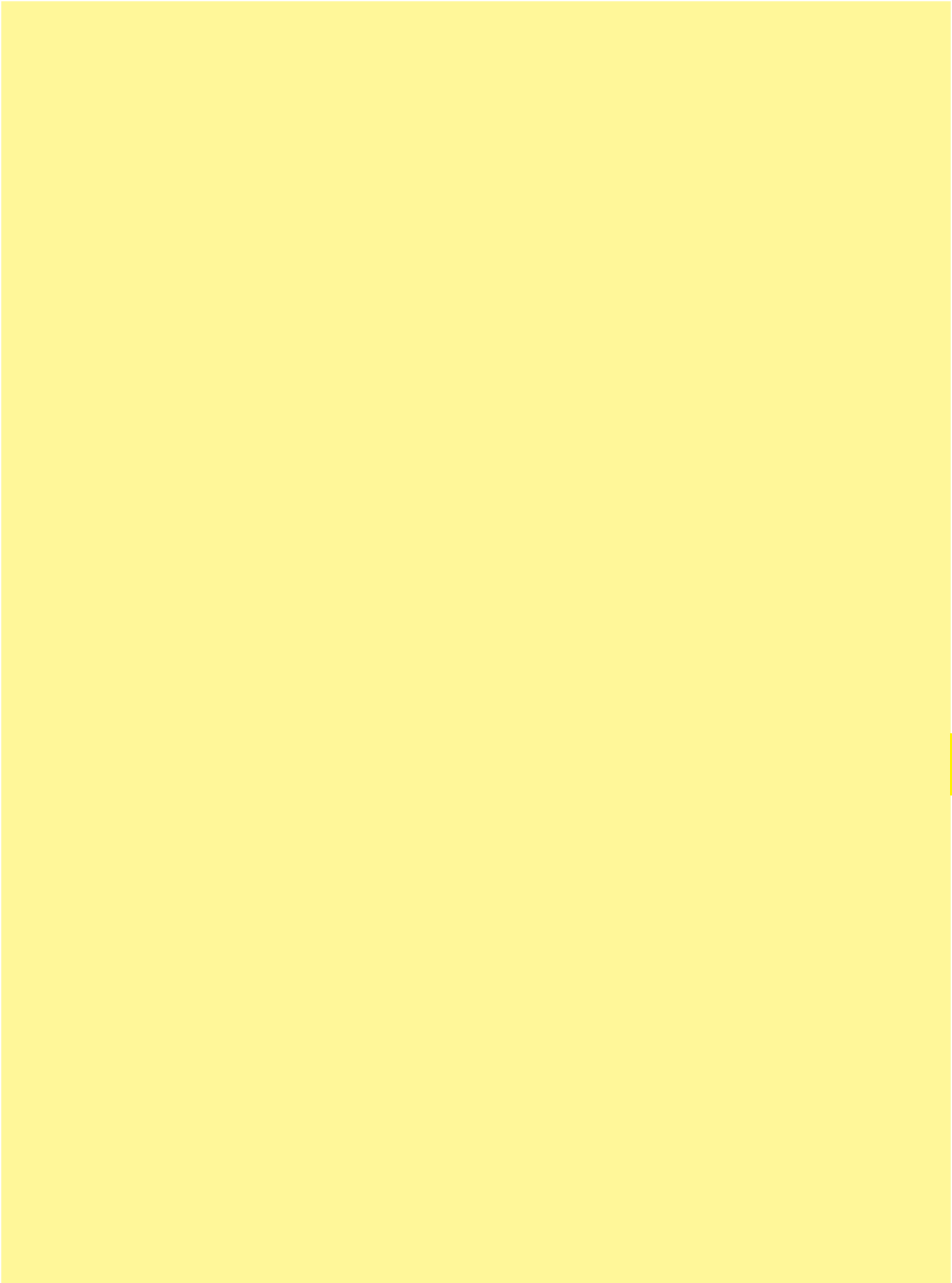

The **harbus[®] HM** Power connector is designed according to the OBSAI Specification V 1.1. It is well-suited to be used in conjunction with 2 mm **harbus[®] HM** connectors. The durability is according to IEC 61076-4-101 (250 mating cycles).

The straight female connector for the backplane is fitted with press-in contacts, the right angled male connector for daughter cards can be supplied with either, press-in or PIHIR (Pin In Hole Intrusive Reflow) termination.

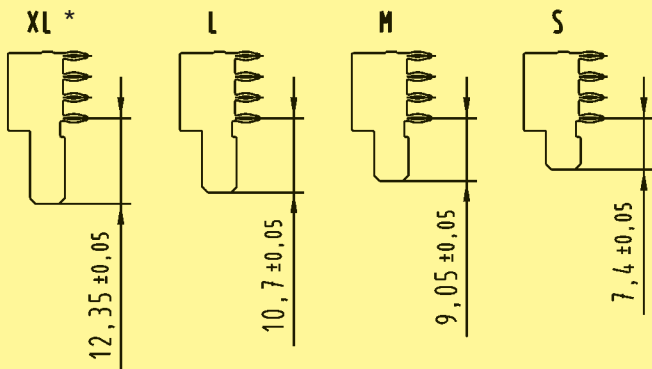

The compact, high temperature moulding can be loaded with up to four high current contacts. Four different contact lengths are available from 7.4 mm to 12.35 mm. This makes sequenced and non-sequenced loadings possible (e.g. with GND and ENA). Any other contact assignments, also partially loaded, are available on request.

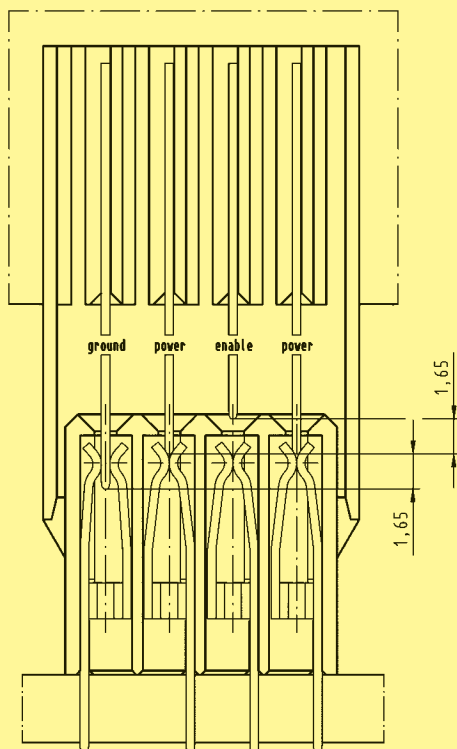

Loaded with four power contacts, each contact can carry up to 20 A @ 70 °C / 80% derating.

With a configuration of two power contacts, GND and ENA, the current carrying capacity is even up to 23 A @ 70 °C / 80% derating per contact.

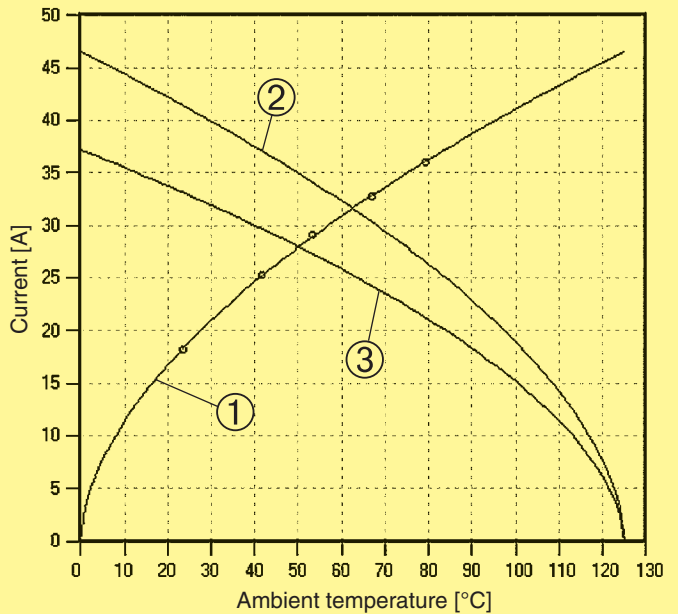

- ① Temperature raise
- ② Derating
- ③ Derating curve at $I_{max} \times 0.8$ (DIN EN 60512-5-2)

The distance between adjacent contacts is 3 mm, which enables wider pcb traces, larger solder paste areas and an improved heat dissipation. For the female backplane connector no special tooling is necessary due to the flatrock design. For the male connector HARTING offers a special press-in tool (see chapter 20).

HARTING's **harbus[®] HM** Signal and Power connectors meet OBSAI (Open Base Station Architecture Initiative) specifications and provide a reliable and cost effective solution for connecting plug-in units to the backplane. The connector solutions available from the HARTING technology group will offer full compatibility and intermateability with base station modules.

Benefits:

- Small form factor
- High current rating up to 23 A per contact (OBSAI configuration)
- 3 level staggering (or even 4)
- Flatrock design
- Matched with **harbus[®] HM** 2 mm connectors

* Type XL on request

Design according	: OBSAI System Spezifikation V 1.1
Number of contacts	: up to 4
Contact spacing	: 3.00 mm
Clearance and creepage distances between contacts	: > 2.3 mm
Working current	: 23 A max. (OBSAI configuration) 20 A max. (fully loaded with power contacts)
Test voltage $U_{r.m.s.}$: AC 1500 V min.
Contact resistance	: < 1 m Ω
Insulation resistance:	: > 10 G Ω
Temperature range	: - 55 °C ... + 125 °C
during reflow soldering	220 °C for 2 minutes, 260 °C max. short-term
Durability as per IEC 61 076-4-101	: <i>Performance level 2 = 250 mating cycles in total.</i> First 125 mating cycles, then 4 days gas test using 0.5 ppm SO ₂ and 0.1 ppm H ₂ S (at 25 + 2 °C and 75 + 3 % humidity). Measurement of contact resistance. The remaining 125 mating cycles are subject to measurement of contact resistance and visual inspection. No abrasion of the contact finish through to the base material. No functional impairment.
Termination technique	
Male connectors	: Press-in or solder termination, suitable for (lead-free) pin-in-hole reflow soldering
Female connectors	: Press-in termination
Mating force	: max. 4 N / contact
Withdrawal force	: min. 0.5 N / contact
Materials	
Mouldings	: Thermoplastic resin, glass-fibre filled, UL 94-V0
Contacts	: Copper alloy
Contact surface	: Selectively gold plated (contact zone)
Contact styles	: Standard, leading, lagging
Packaging	
Tube	: Male and female connectors
Tape & Reel	: On request for male solder connectors



Male connectors angled, with press-in termination

Identification	Number of contacts	Contact length [mm] termination side	Part number	Contact loading
Connector with same sized contacts	4	2.8	17 61 004 2102	 Position — 4 3 2 1
Connector with same sized contacts	4	2.8	17 61 004 2103	 Position — 4 3 2 1
Connector with leading/lagging contacts OBSAI configuration	4	2.8	17 61 004 2101	 Position — 4 3 2 1
Connector with leading contact	4	2.8	17 61 004 2104	 Position — 4 3 2 1

Contact dimensions [mm]

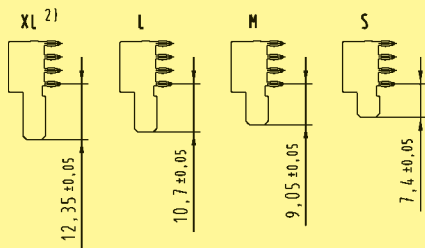

Connector dimensions [mm]

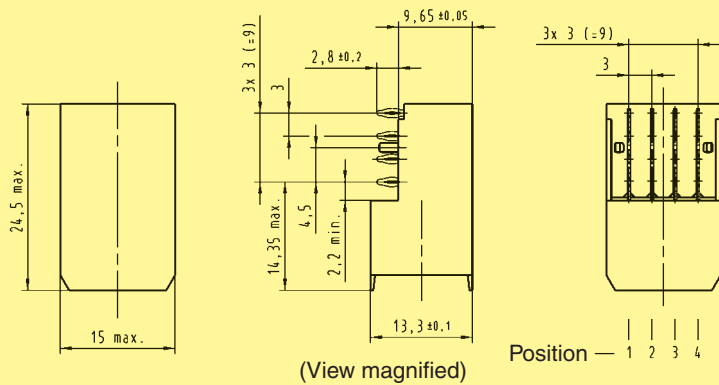

Board drillings

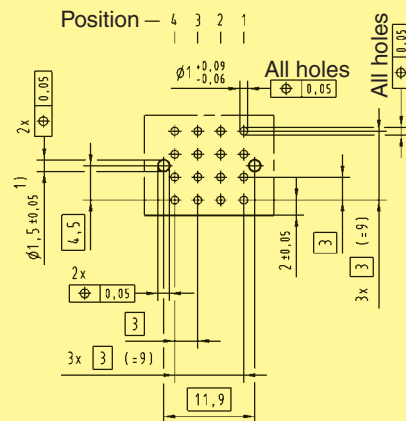

harbus
HM

1) Non-metallized drillings
2) Type XL on request
Tooling see chapter 20

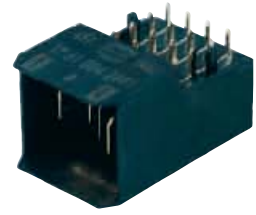

Male connectors angled, with solder (SMC) termination

Identification	Number of contacts	Contact length [mm] termination side	Part number	Contact loading
Connector with same sized contacts	4	2.5	17 61 004 2802	 Position — 4 3 2 1
Connector with leading/lagging contacts OBSAI configuration	4	2.5	17 61 004 2801	 Position — 4 3 2 1

Contact dimensions [mm]

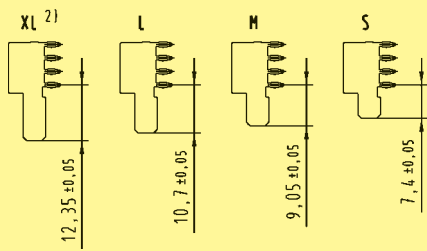

Connector dimensions [mm]

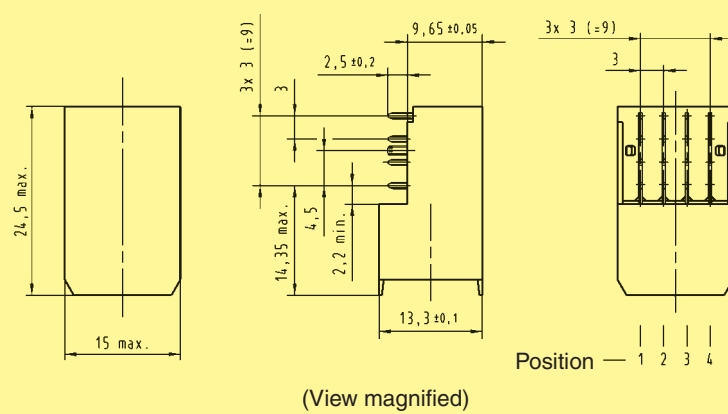

Board drillings

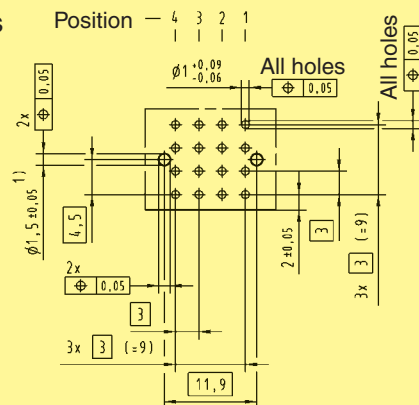

1) Non-metallized drillings
2) Type XL on request



Female connector straight, with press-in termination

Identification	Number of contacts	Contact length [mm] termination side	Part number
Connector with same sized contacts	4	3.7	17 66 004 2201

Connector dimensions [mm]

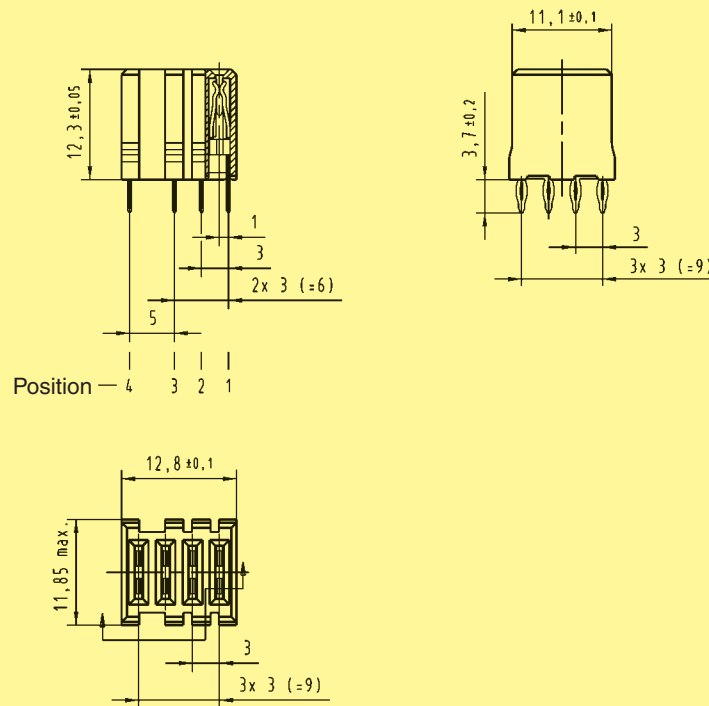

Board drillings

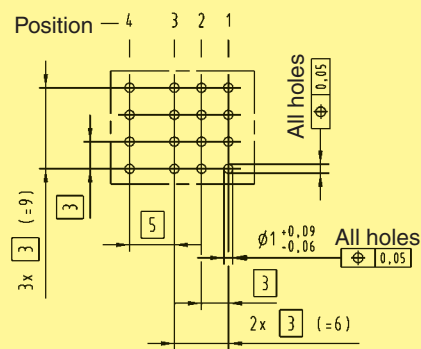

harbus
HM

Coding keys are used to prevent mismatching of boards. They can be inserted into the multifunctional area of male and female connectors with special tooling. This can be easily done after the connectors have been pressed in.

Coding keys have different bright and pre-defined RAL colours to simplify the identification. In the table below the colours and code numbers in acc. with the IEC 61076-4-101 are listed. They are used for the following applications:

- Cadmium yellow for CompactPCI to identify 3.3 V bus signalling
- Brilliant blue for CompactPCI to identify 5.0 V bus signalling
- Reseda green to prevent accidental board insertion in VME64x on CompactPCI applications
- Strawberry red to prevent accidental board insertion in telephony applications
- Pastel orange for user defined bus
- Nut brown for rear I/O and user I/O

Coding keys for male connectors

Coding keys for female connectors

Coding key	Code number	Colour	Part number
	3568	Pastel orange RAL 2003	17 79 000 0010
	3467	Slate grey RAL 7015	17 79 000 0012
	3456	Cadmium yellow RAL 1021 for CPCI, 3.3 V	17 79 000 0013
	2578	Reseda green RAL 6011	17 79 000 0014
	1567	Brilliant blue RAL 5007 for CPCI, 5.0 V	17 79 000 0015
	1356	Blue lilac RAL 4005	17 79 000 0016
	1248	Strawberry red RAL 3018	17 79 000 0018
	1236	Nut brown RAL 8011	17 79 000 0019

Coding key	Code number	Colour	Part number
	1247	Pastel orange RAL 2003	17 79 000 0020
	1258	Slate grey RAL 7015	17 79 000 0022
	1278	Cadmium yellow RAL 1021 for CPCI, 3.3 V	17 79 000 0023
	1346	Reseda green RAL 6011	17 79 000 0024
	2348	Brilliant blue RAL 5007 for CPCI, 5.0 V	17 79 000 0025
	2478	Blue lilac RAL 4005	17 79 000 0026
	3567	Strawberry red RAL 3018	17 79 000 0028
	4578	Nut brown RAL 8011	17 79 000 0029

HARTING's *harbus[®] HM* shrouds protect the pins protruding the rear side of the backplane from irregular mating tolerances, thus ensuring a quality connection.

To accommodate pcb thickness, from 1.6 up to 4 mm nominal, the shrouds have integrated standoffs of corresponding height.

Thus forming a one piece solution that reduces assembling cost significantly.

The shroud can be mounted without the additional requirement of spacers to ensure the desired pin lengths on the rear side of the pcb.

Fixing of the component is carried out on the rear post via a smooth friction fit process.

For ease of assembly the same tooling as for the press-in connectors on the front side is utilised for assembly.

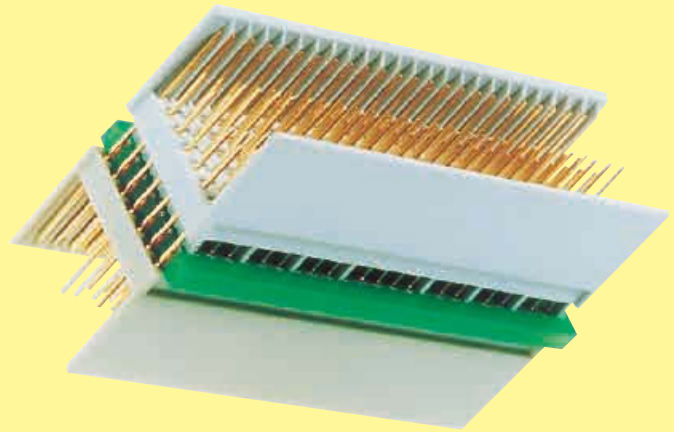



Identification

Board thickness [mm]

Part number

Type A shroud
25 positions

1.6 ± 0.4
 2.4 ± 0.4
 3.2 ± 0.4
 4.0 ± 0.4

17 70 000 1001
17 70 000 1002
17 70 000 1003
17 70 000 1004

Dimensions

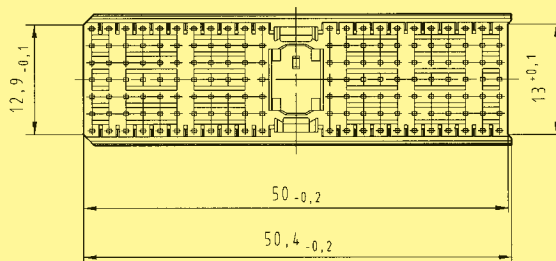
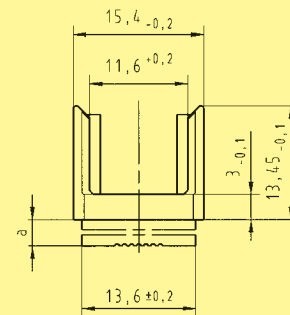
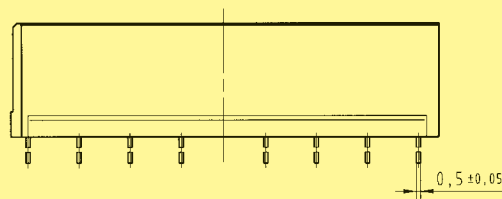
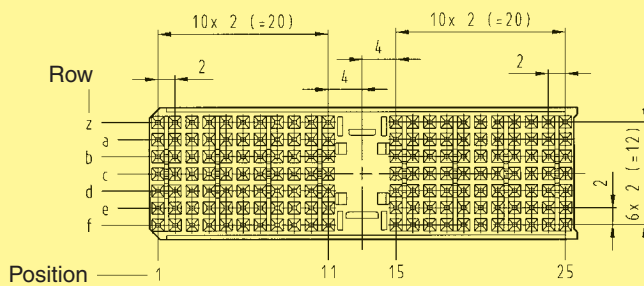

Board thickness [mm]	a [mm]
1.6 ± 0.4	3.1 ± 0.05
2.4 ± 0.4	2.3 ± 0.05
3.2 ± 0.4	1.5 ± 0.05
4.0 ± 0.4	0.7 ± 0.05



Identification	Board thickness [mm]	Part number
Type B shroud 25 positions	1.6 ± 0.4	17 70 000 2001
	2.4 ± 0.4	17 70 000 2002
	3.2 ± 0.4	17 70 000 2003
	4.0 ± 0.4	17 70 000 2004
22 positions	1.6 ± 0.4	17 70 000 4001
	2.4 ± 0.4	17 70 000 4002
	3.2 ± 0.4	17 70 000 4003
	4.0 ± 0.4	17 70 000 4004
19 positions	1.6 ± 0.4	17 70 000 5001
	2.4 ± 0.4	17 70 000 5002
	3.2 ± 0.4	17 70 000 5003
	4.0 ± 0.4	17 70 000 5004

Dimensions

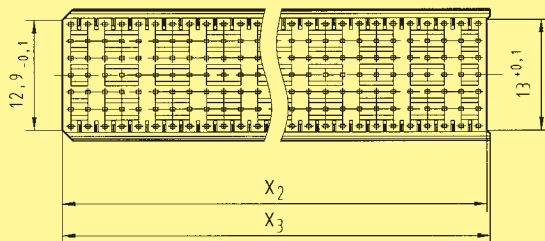
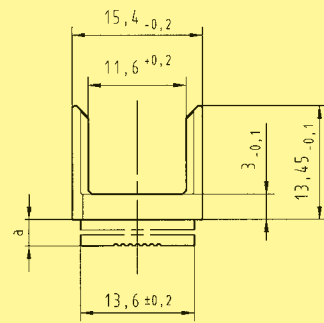
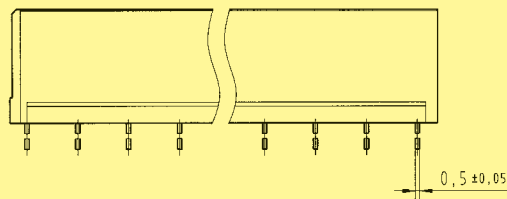
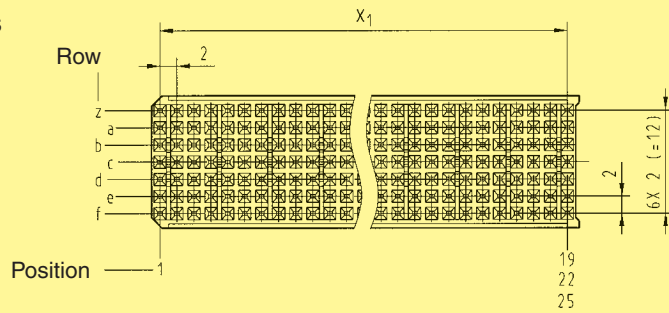

Board thickness [mm]	a [mm]
1.6 ± 0.4	3.1 ± 0.05
2.4 ± 0.4	2.3 ± 0.05
3.2 ± 0.4	1.5 ± 0.05
4.0 ± 0.4	0.7 ± 0.05

Contact positions	x ₁ [mm]	x ₂ [mm]	x ₃ [mm]
19	18 x 2 (= 36)	38 - 0.2	38.4 - 0.2
22	21 x 2 (= 42)	44 - 0.2	44.4 - 0.2
25	24 x 2 (= 48)	50 - 0.2	50.4 - 0.2

Dimensions [mm]



Identification	Board thickness [mm]	Part number
Type AB shroud 25 positions	1.6 ± 0.4	17 70 000 8001
	2.4 ± 0.4	17 70 000 8002
	3.2 ± 0.4	17 70 000 8003
	4.0 ± 0.4	17 70 000 8004
22 positions	1.6 ± 0.4	17 70 000 7001
	2.4 ± 0.4	17 70 000 7002
	3.2 ± 0.4	17 70 000 7003
	4.0 ± 0.4	17 70 000 7004
19 positions	1.6 ± 0.4	17 70 000 6001
	2.4 ± 0.4	17 70 000 6002
	3.2 ± 0.4	17 70 000 6003
	4.0 ± 0.4	17 70 000 6004

Dimensions

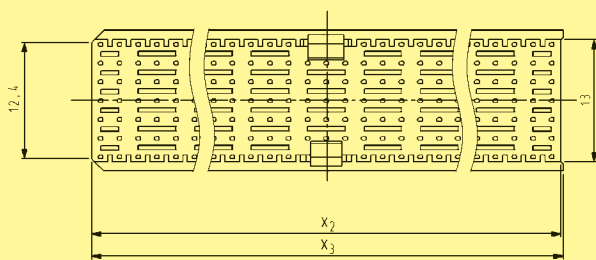
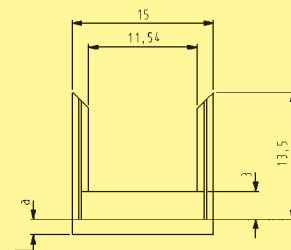
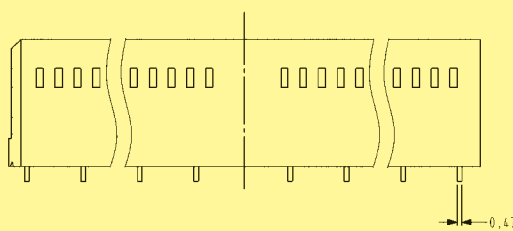
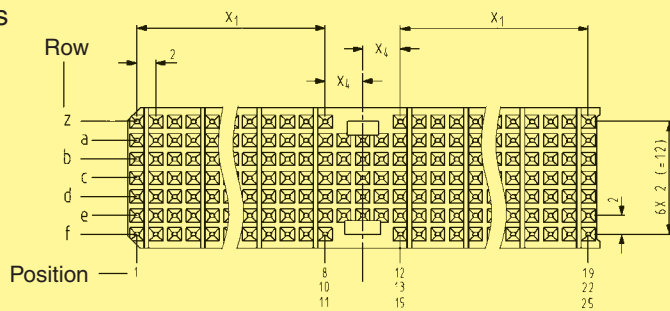

Board thickness [mm]	a [mm]
1.6 ± 0.4	3.1 ± 0.05
2.4 ± 0.4	2.3 ± 0.05
3.2 ± 0.4	1.5 ± 0.05
4.0 ± 0.4	0.7 ± 0.05

Contact positions	x ₁ [mm]	x ₂ [mm]	x ₃ [mm]	x ₄ [mm]
19	7 x 2 (= 14)	37.9	38.2	4
22	8 x 2 (= 16)	43.9	44.2	3
25	10 x 2 (= 20)	49.9	50.2	4

Dimensions [mm]



Identification	Board thickness [mm]	Part number
Type C shroud 11 positions	1.6 ± 0.4	17 70 000 3001
	2.4 ± 0.4	17 70 000 3002
	3.2 ± 0.4	17 70 000 3003
	4.0 ± 0.4	17 70 000 3004

Dimensions

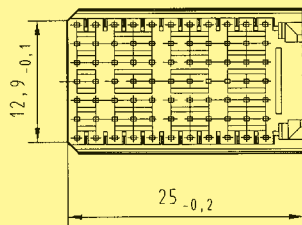
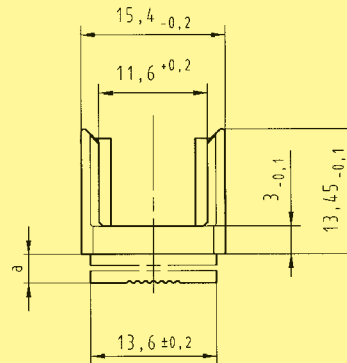
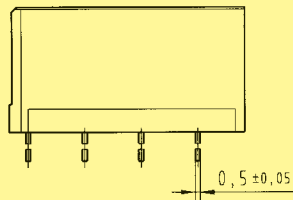
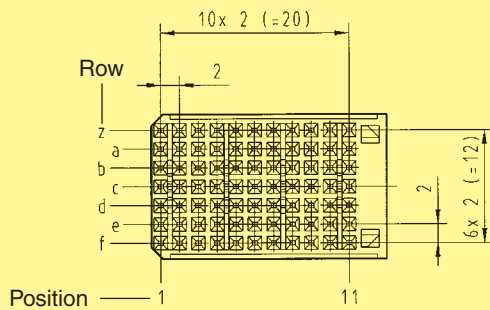

Board thickness [mm]	a [mm]
1.6 ± 0.4	3.1 ± 0.05
2.4 ± 0.4	2.3 ± 0.05
3.2 ± 0.4	1.5 ± 0.05
4.0 ± 0.4	0.7 ± 0.05

HARTING customer request form*

Should you need a specially loaded connector for your application, please use this request form. Fill out the drawing for the desired connector style and mark each position with the required contact length (A, B, ..., S, T).

Type A

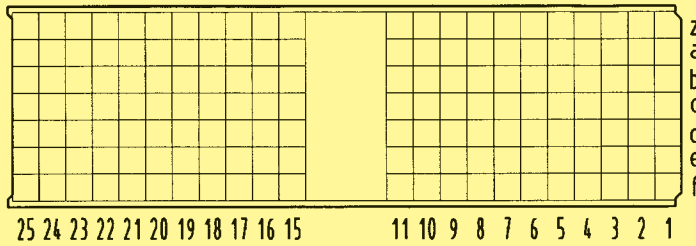

Contact dimensions [mm]

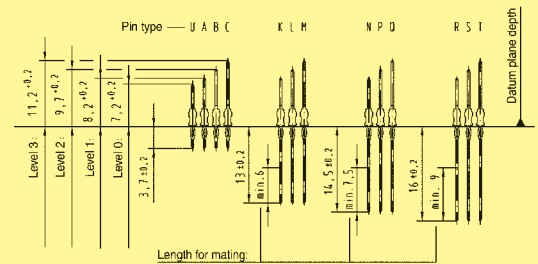

Type B (19, 22 or 25 positions)

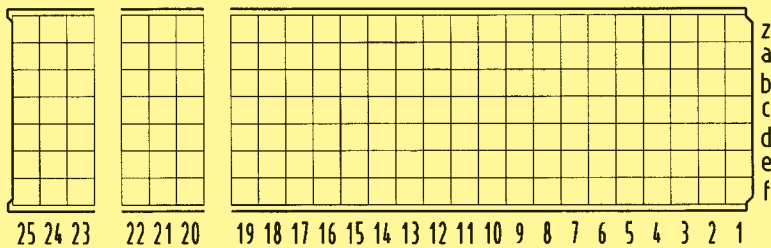

Type C

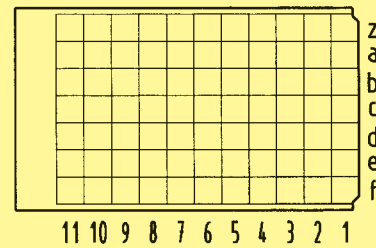

Type Monoblock 47

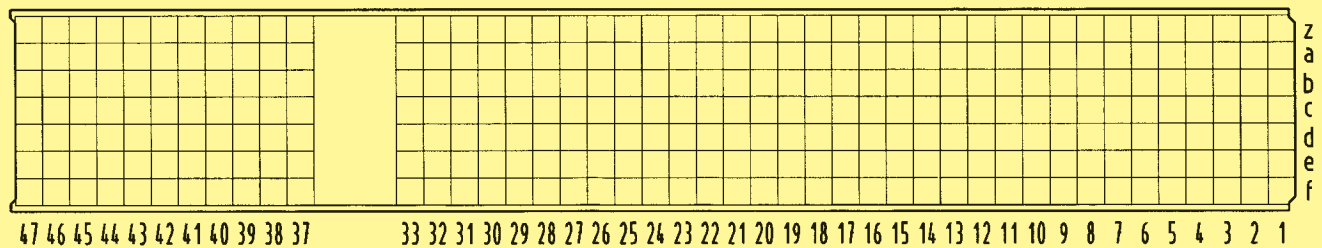

Name: _____

Performance level: 1 2

Company: _____

Drawing: yes no

Address: _____

Samples: no yes, quantity

Volume (pcs./year): _____

Phone: _____

Fax: _____

Special requirements: _____

E-Mail: _____

HARTING customer request form

Should you need a specially loaded connector for your application, please use this request form. Fill out the drawing for the desired connector style and mark each position with the required contact length (A, B, ..., S, T).

Type AB (19 positions)

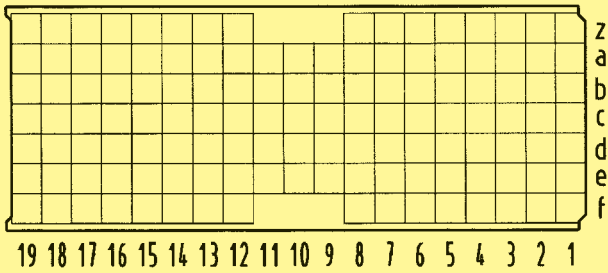

Contact dimensions [mm]

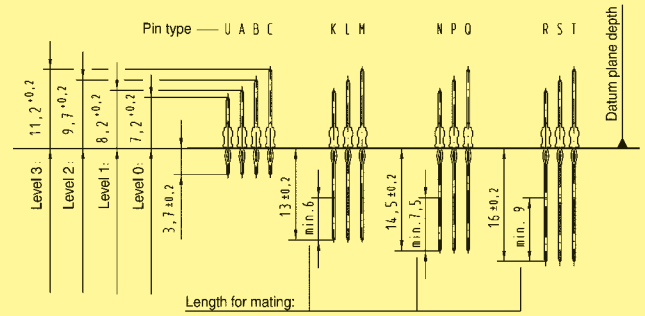

Type AB (22 positions)

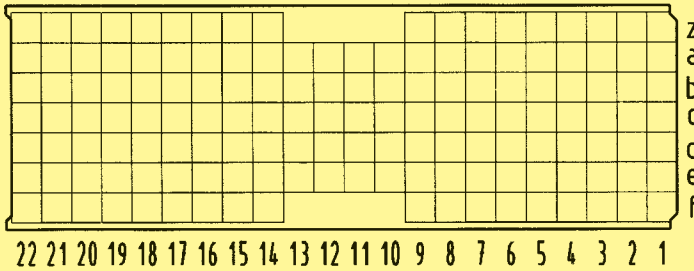

Type AB (25 positions)

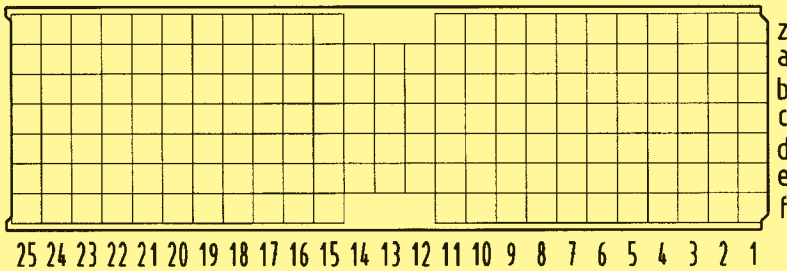

Name: _____

Performance level: 1 2

Company: _____

Drawing: yes no

Address: _____

Samples: no yes, quantity

Phone: _____

Volume (pcs./year): _____

Fax: _____

Special requirements: _____

E-Mail: _____

HARTING customer request form

Should you need a specially loaded connector for your application, please use this request form. Fill out the drawing for the desired connector style and mark each position with the required contact length (A, B, ..., S, T).

Type D

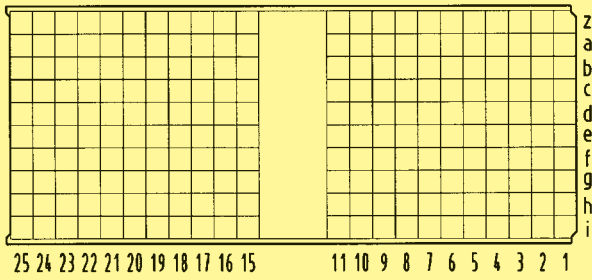

Contact dimensions [mm]

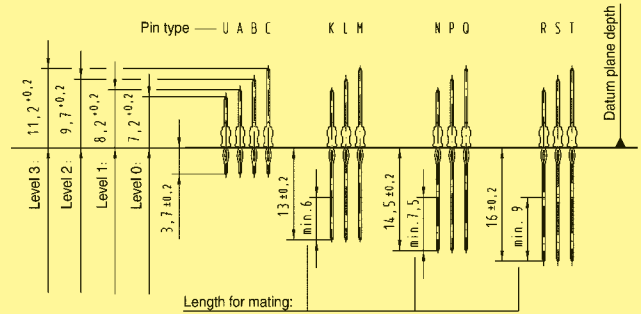

Type E

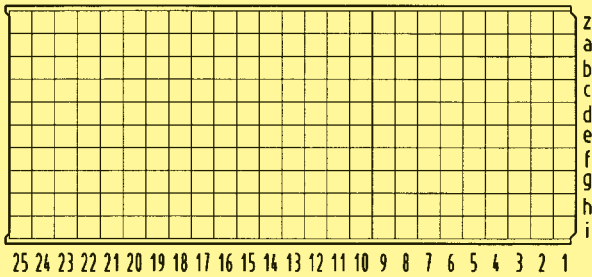

Type DE

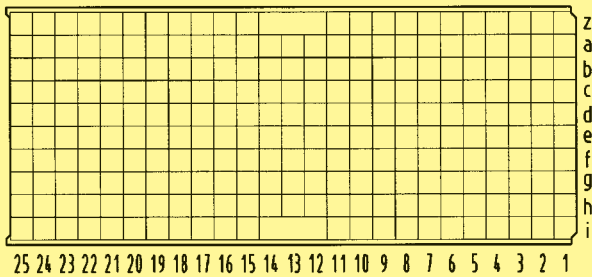

Name: _____

Performance level: 1 2 _____

Company: _____

Drawing: yes no _____

Address: _____

Samples: no yes, quantity _____

Volume (pcs./year): _____

Phone: _____

Fax: _____

Special requirements: _____

E-Mail: _____

